

# MRR-2

## Micro Rain RADAR

### User Manual





METEK  
Meteorologische Messtechnik GmbH

Fritz-Strassmann-Strasse 4  
25337 Elmshorn  
Germany

Fon +49 4121 4359-0  
Fax +49 4121 4359-20  
e-mail [info@metek.de](mailto:info@metek.de)  
internet <http://www.metek.de>

Copyright: © 2016 METEK GmbH

All Rights reserved. No part of this manual may be reproduced, transmitted, stored in a retrieval system, nor translated into any human or computer language, in any form or by any means, electronic, mechanical, optical, chemical, manual, or otherwise, without the prior written permission of the copyright owner.

## Table of Contents

<b>1</b>	<b>Safety Guidelines .....</b>	<b>6</b>
<b>2</b>	<b>Sicherheitsrichtlinien .....</b>	<b>8</b>
<b>3</b>	<b>How to use this manual .....</b>	<b>11</b>
<b>4</b>	<b>Measuring Principle .....</b>	<b>12</b>
<b>5</b>	<b>System Description .....</b>	<b>13</b>
5.1	Overview .....	14
5.2	Description of the Components .....	15
5.2.1	Parabolic Dish .....	15
5.2.2	Antenna Heating (Option).....	15
5.2.3	RADAR Control and Processing Device and Transceiver .....	16
5.2.4	Junction Box / Power Supply .....	17
5.2.5	Control Cable and Serial Cable .....	18
5.2.6	MRR-PC .....	18
<b>6</b>	<b>Hardware Installation .....</b>	<b>21</b>
6.1	General Provisions .....	21
6.2	Site Conditions .....	21
6.3	Installation Procedure.....	22
<b>7</b>	<b>Control Program .....</b>	<b>25</b>
7.1	Installation .....	25
7.2	Limitations using Windows 7, Windows 8 or Windows 10 .....	29
7.3	Using the Control Program .....	30
7.3.1	Main Menu.....	31
7.3.2	Control Commands Menu.....	32
7.3.3	Output Parameters Menu .....	33
7.3.4	Device Parameters Menu .....	35
7.3.5	Parameter Storage .....	37
7.3.6	Status messages.....	39
7.4	Processed and averaged data.....	41
7.4.1	Format description.....	41
7.4.2	Processed and averaged data example .....	46

7.5	Raw Spectra .....	49
7.5.1	Format Description.....	49
7.5.2	Raw Spectra Example.....	50
7.6	Removing of the Software.....	51
<b>8</b>	<b>Detailed description of the MRR-2 control program .....</b>	<b>53</b>
8.1	MRR-Service.....	54
8.1.1	Communication .....	54
8.1.2	Data Recording .....	54
8.1.3	Error Handling.....	56
8.2	Control Program.....	57
<b>9</b>	<b>MRR-2 Specifications .....</b>	<b>60</b>
<b>10</b>	<b>Manual Revisions.....</b>	<b>62</b>

## 1 Safety Guidelines

It is the obligation of the operator of a METEK MRR system to assure that any transportation, set up, operation or dismantling of the MRR system or any other attached technical components at a measuring site is performed exclusively by trained and skilled personnel and according to the system documentation which consists of:

- This manual
- To be regarded but not explicitly listed here are the manuals and datasheets of vendor parts (e.g. DELL PC).

It is recommended to train the operational personnel at least every 12 months on all work or actions associated with the transportation, set up, operation or other work at the site or of the METEK MRR system or on any other technical component!

### **Safety risks:**

- METEK MRR systems are delivered with a power supply at 230 VAC which provides both, high voltages and high currents, which can be hazardous for staff personnel or for other persons within the vicinity and may cause severe or even fatal injuries!
- The external 230 VAC power outlet connected to the MRR system needs a ground fault circuit interrupter 0,03A (RCD); fuse 16A.
- The MRR must not be set into operation unless all set up work and safety installations are done properly! This includes the provision of an earthing peg for grounding of the system.
- For any work at the MRR site which might include installation, operation, repair, maintenance or dismantling the personnel must be aware of further risks which might occur. Some of these risks will become more dangerous in case of poor daylight conditions or at night time. Therefore any work case under poor daylight conditions or at night time should be avoided or with extra care performed. Such risks are:

- Slippery surfaces can cause falling of persons when working around the system or at the system surfaces of the supporting stand.
  - Persons can step on cables or trip by cables or guy lines. If reasonable some flags can be used to mark the cables and guy lines to make them more easy to detect. If possible cables should be hanged up to avoid tripping by them.
  - The grounding nail should be placed beneath antennas so it is impossible to trip.
- 
- Also related to a safe use of the MRR is the avoidance of misuse of the system or of system components.
  - do not open the outdoor boxes of antenna electronic or power supply unless in dry weather periods without liquid or solid precipitation.
  - when opening the outdoor boxes of antenna electronic or power supply dry or wipe off any rain drops, hail stones or snow on top to avoid that this particles will fall inside the opened box.

**Disclaimer:**

METEK GmbH does not take any obligation for any damages of persons, of animals, of materials or any other items which might result from the transportation, set up, operation or dismantling of the MRR system or any other attached technical components or items which are delivered by METEK with the MRR system if the MRR system has not been operated properly according to all above listed instructions or has not been operated within the specified operating conditions! Moreover METEK limits its obligation for proven damages of persons, of animals, of materials or any other items which might result from the transportation, set up, operation or dismantling of the MRR system or any other attached technical components or items which are delivered by METEK with the MRR system to a maximum amount which equals the price of the purchased items as far as no other laws or directives are applicable.

## 2 Sicherheitsrichtlinien

Es liegt in der Verantwortung des Betreibers des METEK MRR Systems sicherzustellen, dass jeder Transport, Aufbau Betrieb oder Abbau des MRR Systems nur durch geschultes und qualifiziertes Personal entsprechend der Gerätedokumentation erfolgt. Die Dokumentation besteht aus folgenden Dokumenten:

- diesem Handbuch
- außerdem müssen Handbücher und Datenblätter von Zubehörteilen betrachtet werden (z.B. Dell PC), auch wenn sie hier nicht explicit genannt sind.

Wir empfehlen, das Bedienpersonal mindestens alle 12 Monate erneut mit den Sicherheitsrichtlinien für den Transport, Aufbau, Betrieb oder Abbau des MRR Systems vertraut zu machen.

### **Sicherheitsrisiken:**

- METEK MRR Systeme werden für den Anschluss an 230 VAC Netzspannung geliefert. Dieser 230 VAC Anschluss stellt hohe Spannungen und Ströme bereit und kann schwere und auch tödliche Verletzungen verursachen.
- Der 230 VAC Anschluss für das MRR System ist mit einem Fehlerstromschutzschalter mit einem Nennfehlerstrom von 30 mA auszurüsten.
- Das MRR System darf erst dann in Betrieb gesetzt werden, wenn alle Sicherheitsrichtlinien beachtet wurden. Dies beinhaltet auch die ordnungsgemäße Installation des Erdungsankers zur Erdung des Systems.
- Bei allen Arbeiten am Messplatz wie Installation, Betrieb, Reparatur, Wartung oder Abbau muss dem Personal bewusst sein, dass überall weitere Gefahren lauern. Einige dieser Gefahren können durch schlechte Lichtverhältnisse bei fehlendem Tageslicht oder zur Nachtzeit verursacht werden. Daher sollten Arbeiten bei diesen Verhältnissen nicht oder nur mit besonderer Vorsicht durchgeführt werden.

Einige dieser Gefahren sind:

- In der Umgebung des MRR Systems kann es zu SRS-Unfällen (Stolper-, Rutsch- oder Sturzunfällen) kommen.  
Ursache hierfür können u.a. sein:
  - schlechte Lichtverhältnisse
  - Stolpern über Kabel, Abspannseile. Es kann daher sinnvoll sein, die Kabel und Abspannseile durch Flaggen entsprechend zu markieren. Kabel sollten nicht am Boden



- verlegt werden, sondern mit geeigneten Pfählen hochgelegt werden.
- Stolpern und Stürzen über Erdungsanker, der Anker sollte daher so platziert werden, dass die Stolpergefahr minimiert wird.
- Für die Sicherheit ist der bestimmungsgemäße Betrieb des MRR Systems wichtig, daher gilt:
  - Öffnen Sie die Gehäuse im Außenbereich nur bei trockener Witterung ohne feuchten oder festen Niederschlag. Entfernen Sie vor dem Öffnen Wassertropfen, Hagel oder Schnee vom Gehäuse, damit kein Wasser in das Gehäuse tropft.

### **Haftungsausschluss:**

METEK GmbH übernimmt keine Haftung für Schäden an Personen, Tieren, Material oder anderen Dingen, die durch den Transport, Aufbau, Betrieb oder Abbau des MRR Systems oder anderen technischen Komponenten, die von METEK mit dem MRR geliefert wurden, entstehen, wenn das MRR System nicht bestimmungsbemäß nach den obigen Anweisungen innerhalb der technischen Spezifikationen betrieben wurde.

Weiterhin beschränkt METEK die Haftung für nachgewiesene Schäden an Personen, Tieren, Material oder anderen Dingen die durch den Transport, Aufbau, Betrieb oder Abbau des MRR Systems oder anderen technischen Komponenten die von METEK mit dem MRR geliefert wurden, auf einen Höchstbetrag, der dem Kaufpreis dieser Waren entspricht, sofern diesem Vorgehen keine gesetzlichen Regelungen entgegenstehen..



### 3 How to use this manual

---

The delivered hardware items are described in chapter 5. Make sure that the delivery is complete and free of damage. Consult chapter 6 for setting up the hardware. In chapter 7 the installation and use of the control software is described. The technical specifications are listed in chapter 9.

Chapter 8 contains more detailed information which is not needed for standard operation.

All auxiliary information marked by a grey vertical line on the left margin may be skipped at first reading as it is not needed for standard setting up and operation.

## 4 Measuring Principle

The Micro Rain Radar MRR-2 retrieves quantitative rain rates, drop size distributions, radar reflectivity, fall velocity of hydro meteors and other rain parameters simultaneously on vertical profiles up to several kilometers above the radar.

It operates with electromagnetic radiation at a frequency of 24.230 GHz with a modulation of 0.5 – 15 MHz according to the height resolution (e.g. 300 m – 10 m). The radiation is transmitted vertically into the atmosphere where a small portion is scattered back to the antenna from rain drops or other forms of precipitation.

Due to the falling velocity of the rain drops on the antenna there is a frequency deviation between the transmitted and the received signal (Doppler frequency). This frequency is a measure for the falling velocity of the rain drops. Since drops with different diameters have different falling velocities the backscattered signal consists of a distribution of different Doppler frequencies. The spectral analysis of the received signal yields a power spectrum which is spread over a range of frequency lines corresponding to the Doppler frequencies of the signal.

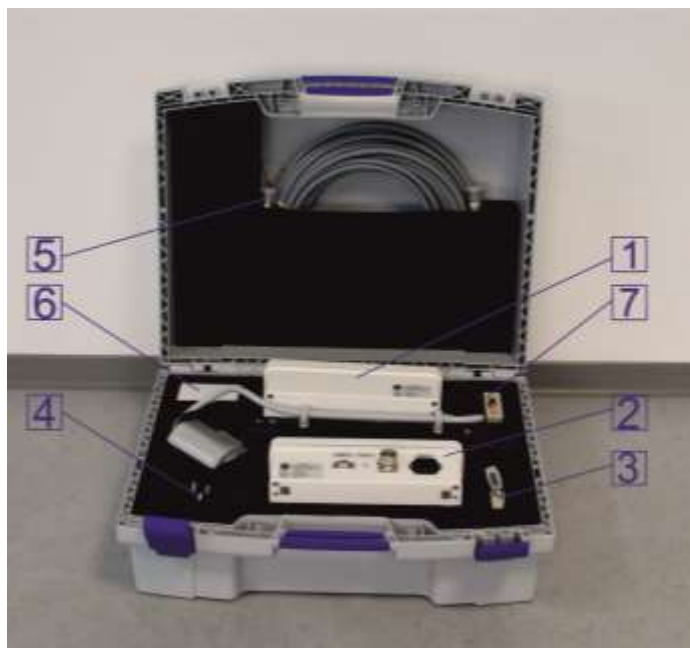
The **RADAR Control and Processing Device (RCPD)** determines this power spectrum with a high time resolution (10 per second) and sends mean power spectra every 10 s to the connected MRR-PC where the reflectivity spectrum is calculated considering the calibration parameters of the RADAR module. Using known relations between fall velocity, rain drop size and scattering cross section the drop spectrum (or drop size distribution) is derived. The integration over the entire drop size distribution, considering further correction terms, followed by further averaging over 10 to 3600 seconds, results in rain rate and liquid water content.

The output signal of the RADAR is transmitted continuously (CW mode), a linearly decreasing saw tooth modulation of the transmit signal (FM mode) makes it possible to perform profile measurements with selectable range resolution.

The RADAR antenna is an offset parabolic dish with vertical beam orientation. This antenna design allows rainwater to drain without building ponds. In order to avoid disturbances from snow which could cover the antenna dish, optional antenna heating is offered.

## 5 System Description

The Micro Rain Radar MRR-2 electronics components are delivered in a heavy duty case.



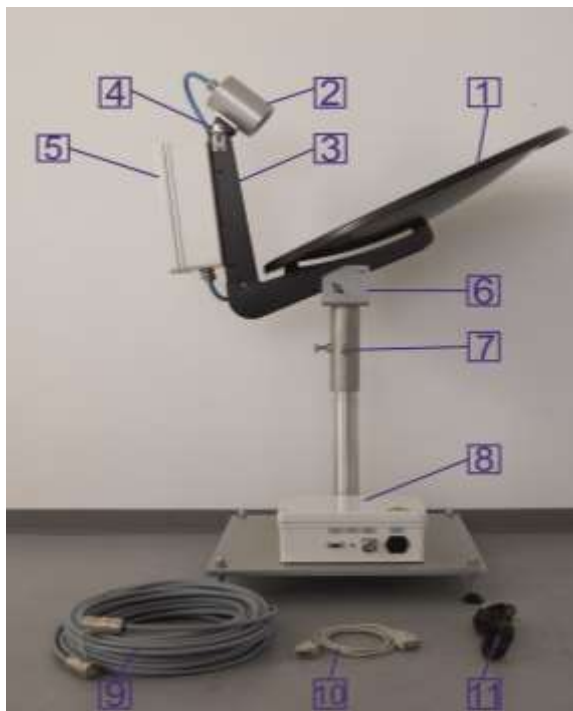
- 1- RCPD
- 2- Junction Box
- 3- Serial Cable
- 4- Power Cable
- 5- Control Cable

Option:

- 6- Power Supply  
LAN-Converter
- 7- LAN-Converter

**Note:** Please always use this case for transportation!

## 5.1 Overview



- 1- Parabolic Dish
- 2- Transceiver
- 3- Antenna Arm
- 4- Bubble Level
- 5- RCPD
- 6- Pivot
- 7- Tube Socket
- 8- Junction Box
- 9- Control Cable
- 10- Serial Cable
- 11- Power Cable

**Figure 1: Components of the System**

The MRR-PC, a commercial PC, (not part of delivery) must be ordered separately. The operating system should be Windows® XP, Windows® 7, Windows® 8 or Windows® 10 (Windows® Versions newer or equal 7 are supported with some limitations).

## 5.2 Description of the Components

### 5.2.1 Parabolic Dish

The antenna is used for the transmission of the RADAR signals and the receiving of backscattered signals. It is designed as an offset parabolic dish (see Figure 1) with a diameter of 60 cm, the beam width is 1.5°. Due to the offset-design of the parabolic dish rainwater can drain off.

For antenna mounting the tube socket (see Figure 1) (inner  $\varnothing = 51$  mm) is to be plugged onto a pole with an outer diameter of max. 50.5 mm. The socket is fastened with M10 screws.

**Connect a ground wire to this screw which serves as a surge protector.**

**Check the vertical alignment of the antenna with the built in bubble level.**

The transmitting and receiving properties of the antenna affect the radar calibration. Therefore the reflector surface should be clean (e.g. free from leaves or wet snow). For the same reason any mechanical deformation of the parabolic dish must be avoided. If nevertheless obvious deformation occurred, the reflector must be replaced.

### 5.2.2 Antenna Heating (Option)



- 1- Parabolic Dish with Heater
- 2- Heater Connection Box
- 3- Heater Power Cable

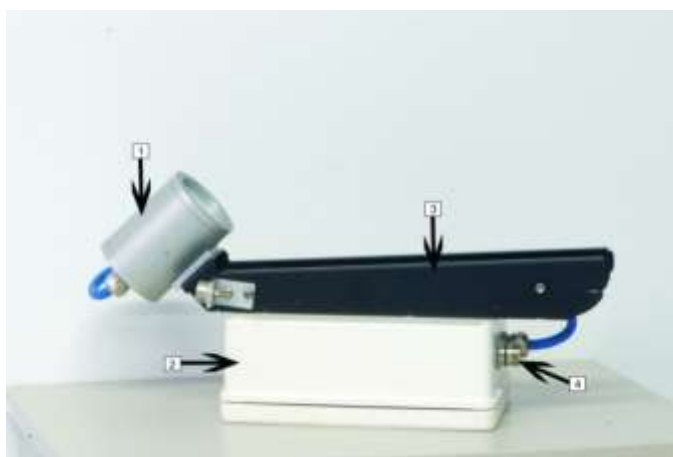
**Figure 2: Antenna Heating**

The back side of the reflector is optionally equipped with a heater coil. It is covered and sealed with a molded lid which provides also extra stability for the reflector. The energy consumption increases with decreasing temperatures and amounts to maximum 500 W. The heating is activated when the temperature falls below a threshold which can be adjusted in the heater connection box (default temperature 5°C). The heater coil works with 230 VAC voltage supply and needs an extra power cable which is connected to the heater connection box (see Figure 2 and Figure 3 ).



**Figure 3: Heater Connection Box**

### 5.2.3 RADAR Control and Processing Device and Transceiver



- 1- Transceiver
- 2- RCPD
- 3- Antenna Arm
- 4- Connector (Control Cable)

**Figure 4: RCPD and Transceiver**

The **RADAR Control and Processing Device RCPD** (see Figure 4) generates the RADAR transmit modulation signal and passes it to the transceiver (see Figure 4). It analyses the backscattered receiver signal, calculates Doppler spectra and transfers average power spectra (referred to as “raw spectra”) to



the MRR-PC where these spectra are interpreted. The RCPD has a water protected IP65 housing which is fixed to the antenna arm (see Figure 4). At the bottom side of the RCPD is the socket (see Figure 4) for the control cable (see Figure 6). The electronic components inside the housing don't need any service. As far as possible the RCPD should not be opened by the user.

#### 5.2.4 Junction Box / Power Supply



**Figure 5: Junction Box**

The junction box is used to pass through the communication between the PC and the RCPD. For this purpose it has a 9-pin D-sub-miniature socket for the serial cable (see Figure 6) to the MRR-PC and a flanged socket for the control cable (see Figure 6) to the RCPD.

The power supply for the RCPD and Transceiver is also integrated in the junction box. An IEC connector for the mains supply of 230 VAC is on the front side of the case. The power supply (24 VDC) for the RCPD and Transceiver is also passed through the control cable (see Figure 6).

All MRR systems produced in 2011 ff. are equipped with an RS422 Interface: The communication between RCPD and Junction Box is on RS422 level. In the Junction Box the signals are converted to RS232 level.

The communication between junction box and PC is on RS232 level.

MRR systems prior to 2011 use only RS232 level for communication, there is no RS422/RS232 converter in the junction box.

**Note:** The junction box is not appropriate for outdoor operation.

### 5.2.5 Control Cable and Serial Cable



**Figure 6: Control Cable (left) and Serial Cable (right)**

The control cable connects the RCPD with the junction box.

The control cable has a length of 25 m, on both ends are screwed plugs (male and female respectively). They must be screwed onto the matching plugs at the junction box (cable has pins) and at the RCPD (cable has sockets).

The serial cable (RS232) connects the Junction Box with the PC.

The maximum length of the serial cable is 2 m, a serial cable with a 9-pin (female) and a 9-pin (male) plug and a length of 1.8 m is delivered. This cable is not appropriate for outdoor applications.

### 5.2.6 MRR-PC

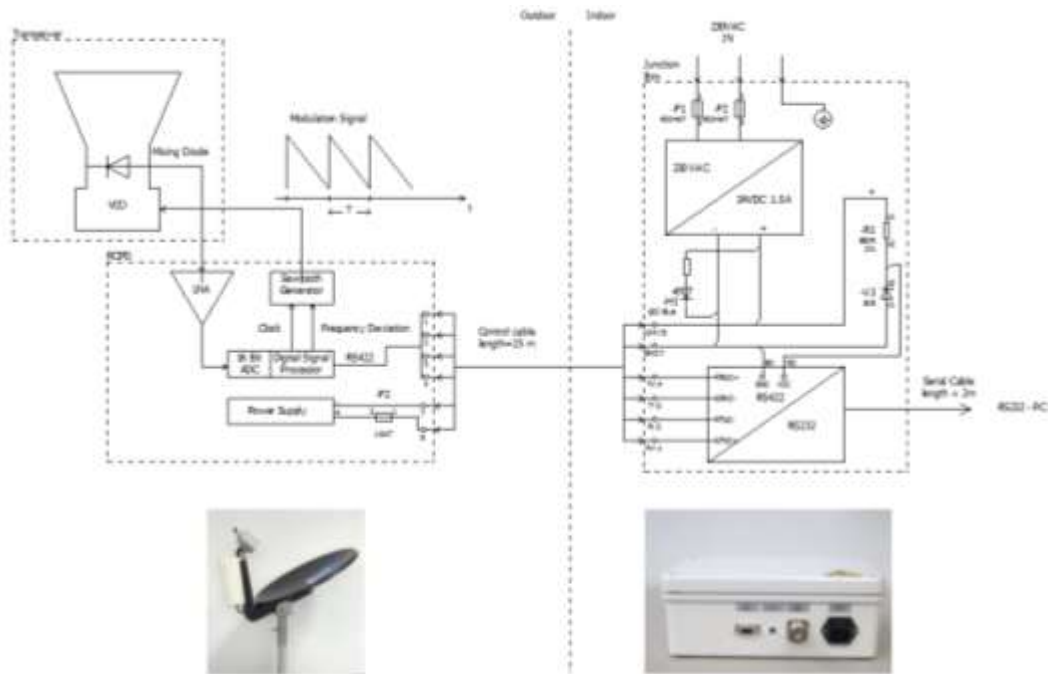
A personal computer (PC) with the operating system Windows® XP, Windows® 7, Windows® 8 or Windows® 10 serves for setting the operation parameters and data evaluation of the MRR. (Windows® 7, Windows® 8 or Windows® 10 are supported with some limitations). The PC must have at least one serial port which will be configured by the control program as follows:

57600 baud,  
8 data bits, no parity,  
Software Handshake (XON/XOFF)

Pinning (D-Sub-9-socket at the junction box) :

Pin 1	CD	<i>carrier detect</i>
Pin 2	RD	<i>receive data</i>
Pin 3	TD	<i>transmit data</i>
Pin 4	DTR	<i>data terminal ready</i>
Pin 5	GND	<i>ground</i>
Pin 6	DSR	<i>data set ready</i>
Pin 7	RTS	<i>request to send</i>
Pin 8	CTS	<i>clear to send</i>
Pin 9	RI	<i>ring indicator</i>

The control program which is needed to operate the MRR-2 is part of delivery. Its installation and operation is described in section 7 *Control Program* page 25.



**Figure 7: MRR block diagram**



## 6 Hardware Installation

### 6.1 General Provisions

- Before you start the system, all cable connections must be set up.
- Only the antenna unit including RCPD, transceiver and control cable (see Figure 1) are designed for outdoor operation. All other components, e.g. the junction box and PC, must be installed in a weather protected environment with temperatures within 5 - 40°C.
- The electronics cases may be opened only in dry environment. Especially in outdoor area you risk damage by moisture.
- If cables are laid on free field, a cable conduit is recommended.
- All cable connections should be protected by strain-reliefs.
- Use only the original connectors. Guarantee is void if other connectors are installed.

### 6.2 Site Conditions

Before actual installation the site must be checked for its suitability for rain measurements.

There must be free view of at least 10° zenith angle over the radar.

Nearby transmitters (base stations of mobile phones, broadcast towers, radars) can cause interference although they operate nominally at different frequency bands. If such neighborhood is necessary, a simple metallic screen or larger object (container) obscuring the direct line of sight to the interfering source can help.

The vicinity of electric machines (e.g. drive of elevators) should be avoided, since they can create interfering signals which are difficult to screen.

If measurements at very low heights are planned, (with appropriate settings the MRR-2 allows measurements from a minimum height of 20 m above ground) take care that the wind field in this level is not disturbed by nearby buildings, trees, masts etc. because strong turbulence could falsify the data.

In contrast with in-situ rain sensors the exposure of the antenna to the free wind field is not detrimental but favorable.

Figure 8 shows various examples of MRR installations: On ground, on top of containers and on top of buildings.



**Figure 8: Examples of MRR installations**

### 6.3 Installation Procedure

#### **Preparations:**

A fixed vertical pole (max. Ø50.5 mm, length min. 30 cm) is required for attaching the antenna. Operating of the MRR-2 requires a 230 VAC mains supply, with a fuse protection of 8 A (slow) minimum. To prevent disturbance of the device by variations or breaks of the power supply we recommend the use of a no-break power supply (UPS).

#### **Required Tools:**

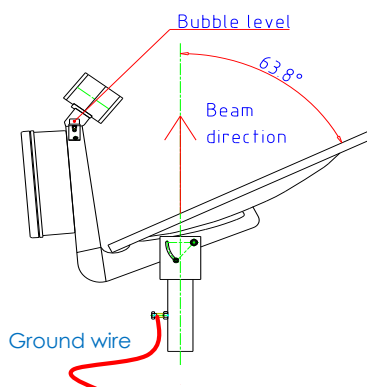
- 13 and 17 mm wrench
- 5 mm hexagon socket screw key

**Installation Steps:**

1. Install the MRR-PC according to the documents of the manufacturer.
2. Connect the tube socket with the antenna (4 screws).



3. Plug the tube socket (see Figure 1) of the RADAR antenna over the attachment pole and clamp it with the M10 fixing bolts.
4. Check the vertical alignment of the antenna with the built in bubble level (Figure 9).



**Figure 9: Vertical alignment of the radar beam**

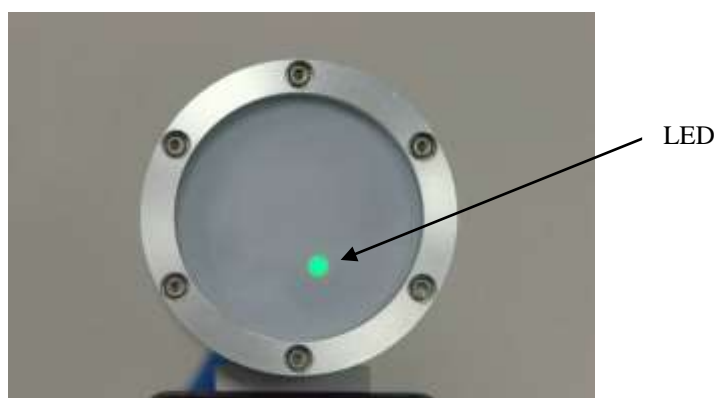
5. Attach a ground wire to the fixing bolt for lightning protection after mounting of the antenna (Figure 9).
6. Connect the control cable between RCPD and Junction Box. Ensure that the nut cap is tightly screwed, If the black o-ring is visible the connection will not be waterproof.



o-ring



7. Connect serial cable (Figure 6) to the serial interface of the MRR-PC which was selected in the operating system for the connection of the MRR-2. If this serial port is unknown, it can be looked up in the administration of the "services" in the operating system of the computer and it can be changed accordingly there. See also installation of the control program chapter 7.
8. Connect power cable of the Junction Box to the mains voltage of 230 VAC.
9. Check the power supply of the Transceiver: If the cabling is Ok a green LED in the Transceiver indicates the correct supply.



**Figure 10: Transceiver with LED**

10. Establish the communication between the control program „MRR-2 Control” and the RCPD-firmware.
11. Check the correct data transmission and recording.



## 7 Control Program

If you use your own PC for controlling the MRR-2 the MRR program is delivered on a USB-Stick and must be installed according chapter 7.1.

If the PC was configured and delivered by METEK (optional) chapter 7.1 may be skipped.

### Note: Ballpoint Device, Serial Mouse

When starting up, Windows sometimes recognizes the incoming serial data as a serial mouse or a ballpoint device. This device must be defined and then disabled one time. Don't uninstall the driver. This prevents Windows to interpret MRR data as mouse motions.

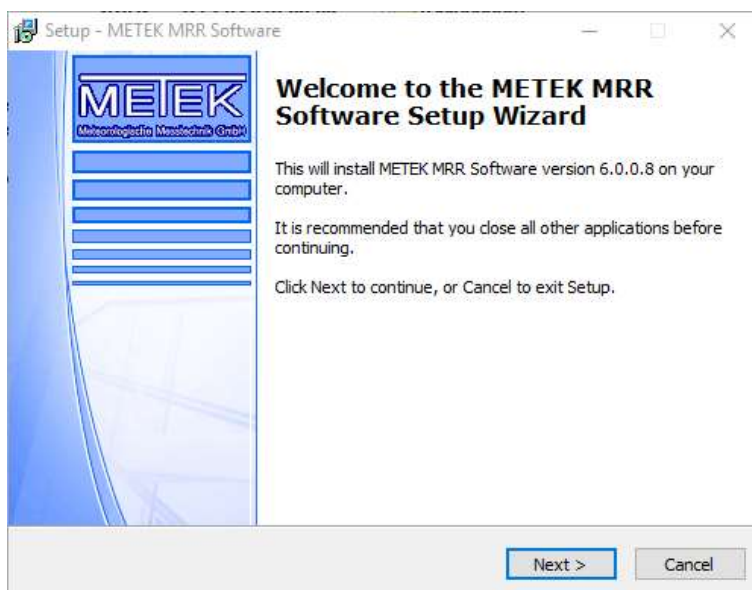
### 7.1 Installation

The software can be installed on a PC with Windows® XP, Windows® 7, Windows® 8 or Windows® 10 (Windows® 7, Windows® 8 or Windows® 10 are supported with some limitations).

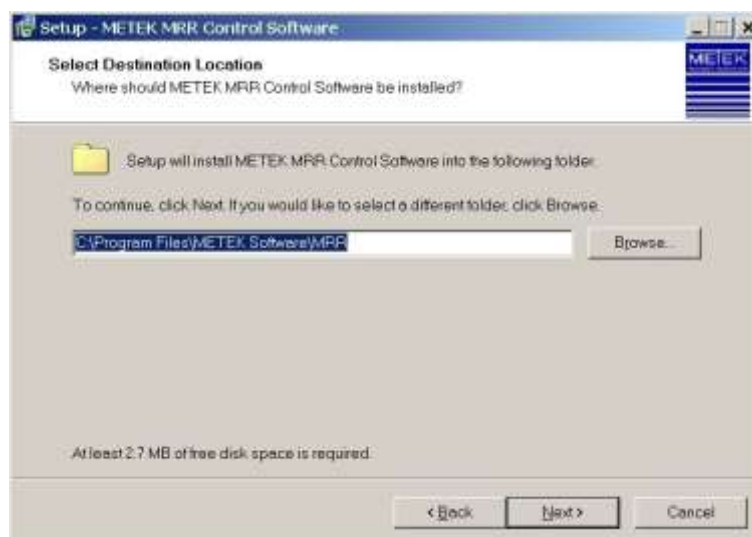
For installing the Control Program:

- Insert the USB-Stick.
- Login as administrator.
- Open the program group `my computer` (icon on the desktop).
- Open the folder for the USB-Stick.
- Change to the folder `METEK`.
- Start the program `MRRSetup_V6006.exe`

The setup program will start with the welcome screen; click the next button to proceed with the installation. The next screen is the destination folder selection (default: `C:\Program Files\METEK Software\MRR`), normally no changes are needed, please confirm with "Next".



**Figure 11: Welcome Screen**



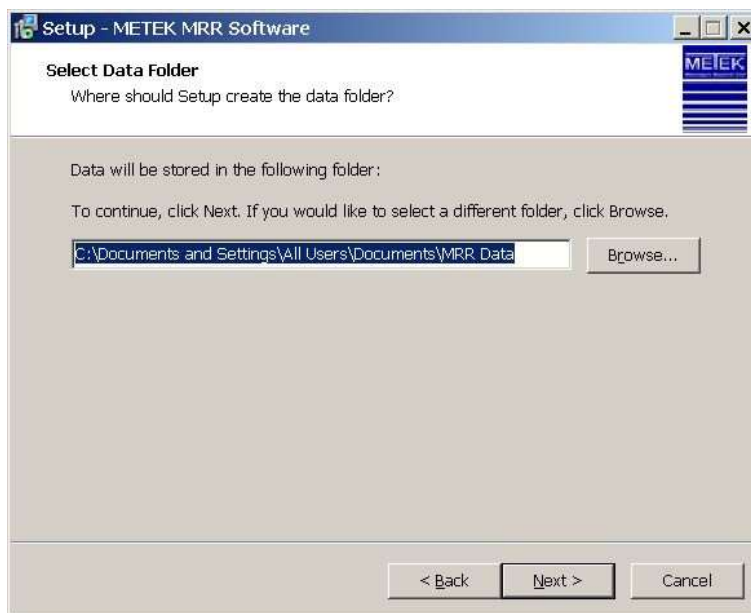
**Figure 12: Destination Folder**

The next screen is the selection of the data folder (Figure 13), the default value for the data folder is

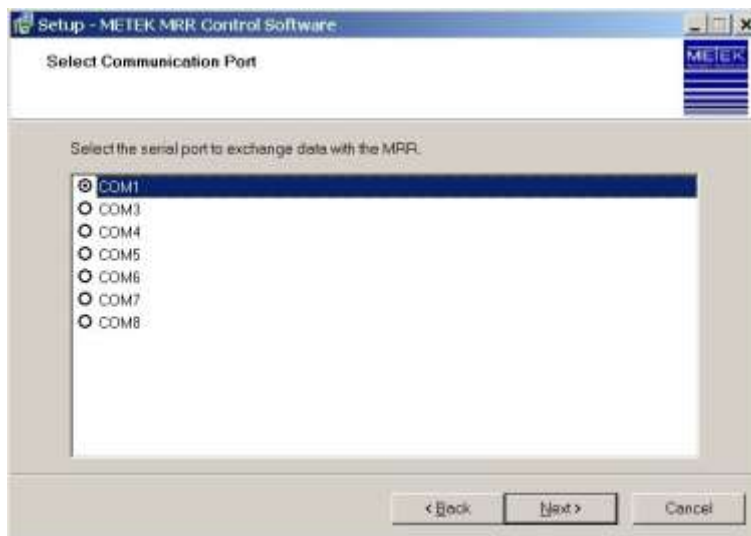
“D:\Documents and Settings\All Users\Documents\MRR Data”

The default value depends on the windows version, please change this value according to your preferences and confirm with “Next”.

In a next step the communication port (Figure 14) is selected: the list of the serial ports shows all available serial ports on your PC, please change this value to your preferences and confirm with “Next”.

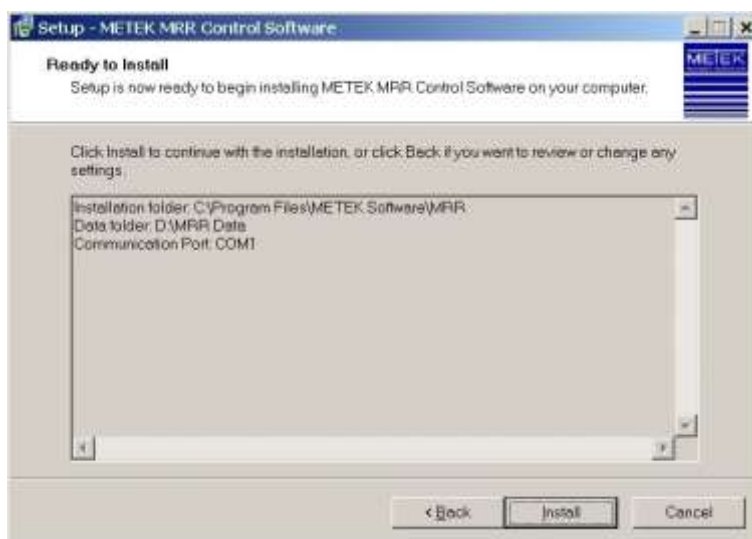


**Figure 13: Data Folder**



**Figure 14: Communication Port**

In the next step all selected values are shown (Figure 15) in a list and you can start the installation by pressing "Install". If you want to make changes before your installation you can go back and change the settings.



**Figure 15: Install**

If you press install, the installation starts and will display a message box:



**Figure 16: Service installed**

In a last step the finish screen disappears, with “Finish” you can terminate the setup program.



**Figure 17: Finish**

**Note:** The data flow rate from the MRR to the PC requires that the PC response time does not exceed certain limits. If the PC was configured and delivered by METEK (optional), meeting of this request is warranted.

Any modern PC with medium performance is basically sufficient to run the MRR Control Program if there are not too many other tasks running simultaneously. Particularly virus scanning programs may slow down the PC

below the minimum possible value. In that case the data records are corrupted.

Please check the integrity of recorded data by visual inspection and reduce the processor load if necessary.

## **7.2 Limitations using Windows 7, Windows 8 or Windows 10**

The MRR control program was originally designed for Windows 2000. If you use the program with Windows® 7, Windows® 8 or Windows® 10 there are some limitations:

- During start of the MRR-Service the service tests if the selected serial port is available and not opened from another application, for your information a message box is displayed if the selected serial port couldn't be opened, additionally a message is written to the event log. With Windows 7, Windows 8 and Windows 10 the message box is not displayed.
- All messages from the MRR Service in the event log in the "Task Category" show the text "incorrect function".
- The help function will only work if you install the Microsoft "KB917607" update.

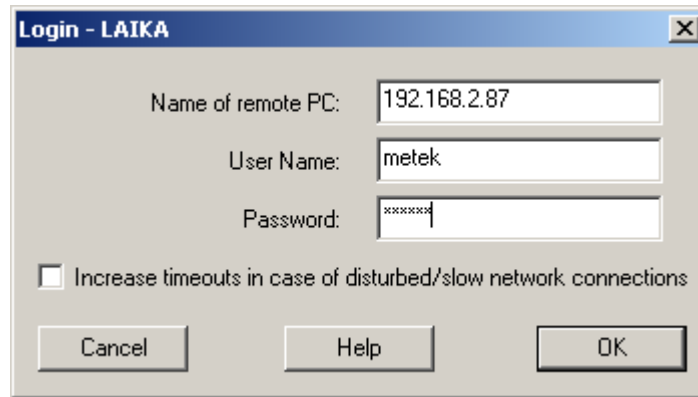
The basic cause of these singularities is an old compiler version which is not fully compatible with Windows® 7, Windows® 8 or Windows® 10.

### 7.3 Using the Control Program

---

After login to the operating system press the “Start” Button and open the menu “METEK Software”, then select “MRR” and then select “MRR Control”.

The following dialogue window appears :



**Figure 18: Login Screen**

If the MRR-PC you are sitting at is the PC which is directly connected to the MRR-2 leave the entry at **Name of the Remote PC** empty (or type a period or the name of the local PC). If you are sitting at another PC, enter the name of that PC to which the MRR-2 is connected directly and where the communication service (`MrrCtrl.exe`) was started.

The User Name is generated automatically and the Password is usually not needed (see below for exceptions).

The **Password** entry field is useful if the remote computer is a member of another Windows domain because in this case a connection can be built up only if a user name and the matching password is given. The user name is set automatically (see the header of the dialog window).

The network connection to the remote computer usually is a LAN- or a RAS connection. RAS connections using the public telephone net are mostly not very efficient, especially connections with mobile phone radio nets. Considering that, the login dialog provides the use of time-out-values which are adjusted to the maximum delay times for the responses from the remote PC. Using a direct LAN or a local login, this feature is not needed.

If the program was started by a command line input, the information concerning the login window can be handed over as a parameter. Example:

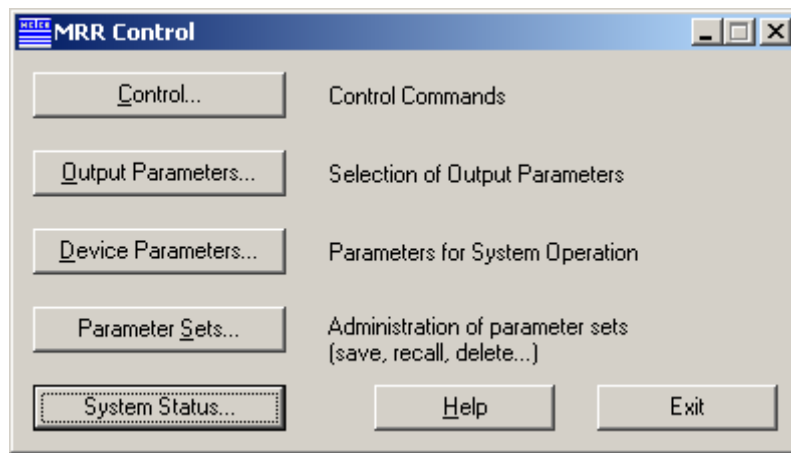
```
C:\METEK\MrrCtrl hostname secret /t
```

This entry would try to build a connection to a computer with the name `\\hostname`. The password is `secret`, the time-out-values are set for slow

WAN connections (/t). The parameter /t is optional, the computer name and the password however must be given always. This is also valid for local logins (the password will not be checked).

If the connection to the communication service could be built up, the entire status of the MRR-2 is read out first. This can take some seconds, on RAS connections even some minutes.

### 7.3.1 Main Menu



**Figure 19: Main Menu**

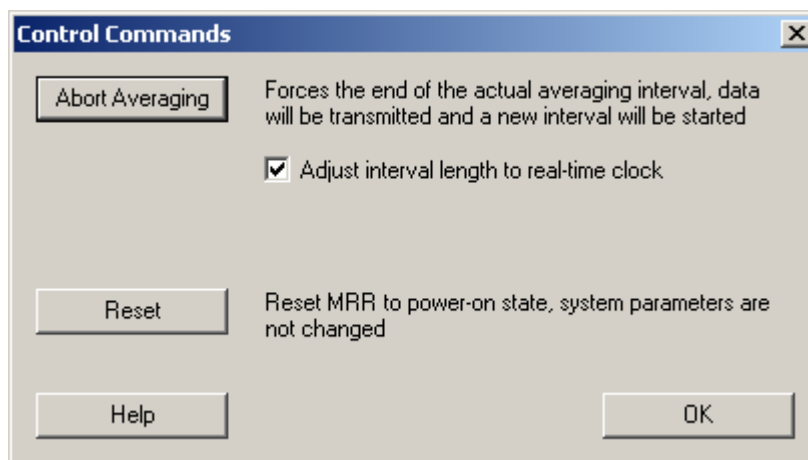
The main menu shows buttons for the menus

<b>Control</b>	chapter 0 on page 32
<b>Output Parameters</b>	chapter 7.3.3 on page 33
<b>Device Parameters</b>	chapter 7.3.4 on page 35
<b>Parameter Sets</b>	chapter 7.3.5 on page 37
<b>System Status</b>	chapter 7.3.6 on page 39

You can leave the program with the **Exit** button.

The **Help** button provides a Windows conforming help text.

### 7.3.2 Control Commands Menu



**Figure 20: Control Commands**

#### **Abort Averaging**

The current averaging interval is stopped. Data, collected since the begin of the averaging interval, are processed and a new averaging interval is started regardless of elapsed averaging time.

#### **Adjust interval length to real time clock**

This checkbox activates the synchronization of measuring intervals to the actual time of day. This means every output of averaged data will occur at 'round' times. Example:

If the measuring time has been set to 600 seconds, output will be generated at every full 10 min.

#### **Reset**

Pressing this button will perform a reset of the RCPD firmware. There is no influence on the MRR-2 parameters. It has the same effect as an interruption of the power supply.



### 7.3.3 Output Parameters Menu



**Figure 21: Output Parameters**

The two upper panels shown in **Figure 21** contain check boxes for configuring selections of *averaged data* and *processed data* (instantaneous data) separately for recording. *Processed data* are calculated on the basis of one raw spectrum<sup>1</sup>. *Averaged Data* are processed on the basis of an average of multiple raw spectra, depending on the selected averaging time. The selectable variables are described in the table below.

Selection of	causes the recording of
<b><i>Height<sup>2</sup></i></b>	Measuring height above ground
<b><i>Spectra</i></b>	Spectral volume reflectivity
<b><i>Drop Spectra</i></b>	Drop diameter and number of drops per volume and diameter
<b><i>Attenuation</i></b>	Two way path integrated attenuation
<b><i>Radar Reflectivity</i></b>	Radar reflectivity factor and attenuated radar reflectivity factor
<b><i>Rain Rate</i></b>	Vertical volume flux of liquid water per unit area
<b><i>Liquid Water Content</i></b>	Mass of liquid water per volume
<b><i>Falling Velocity</i></b>	Doppler velocity (1. moment of the spectrum)

<sup>1</sup> raw spectra and the processed data represent already averages over 10 seconds, these averages are calculated out of approx. 57 instantaneous spectra.

<sup>2</sup> The output variable *Height* should always be selected, as this facilitates further processing of recorded data.

## Recording Options

### Raw Spectra

By checking “Record raw spectra” the raw spectra including metadata are written in addition to other selected data to a separate log-file. The path name of these files is defined by the parameters “RawSpectraFile” and “RawSpectraPath”.

### Conditional recording

By checking “Record only if it rains” data are only recorded if the evaluation software detects precipitation during the measuring (averaging) interval. This condition can be activated separately for averaged/processed data and raw spectra respectively.

### Measuring Height(s)

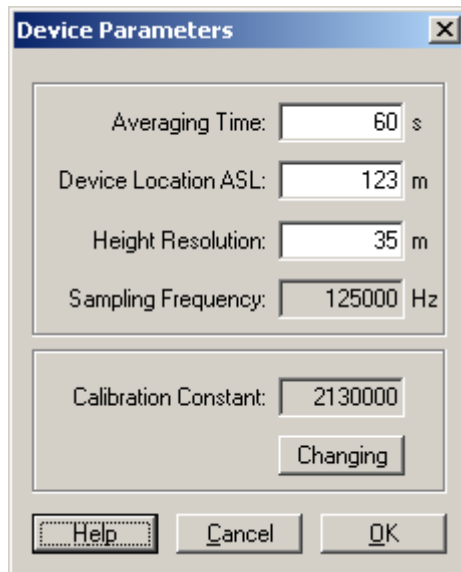
A subset of measuring heights can be selected for recording. This subset is used for both kinds of data output, processed and averaged data. The selection of measuring heights for output is done with two lists containing the selected and unselected height steps. To move items (sets of height steps) between the lists they must be marked in the source list. The movement will be performed when the arrow button pointing to the other target list is pressed. (The *height resolution* (step-width) can be adjusted with the device parameters menu (see chapter 7.3.4 on page 35)).

### Time Zone

The time zone can be selected which is used for the time stamps of the recorded data.

All changes in the Output Parameters Menu become effective by clicking the “Ok” button. Then the corresponding commands are transmitted to the RCPD firmware. Clicking the “Cancel” button cancels all changes.

### 7.3.4 Device Parameters Menu



**Figure 22: Operation Parameters**

#### **Averaging Time**

Here you define the averaging time for the *averaged data*.

The adjustable range is 10 .. 3600 s.

After each averaging time, an *averaged data* set is generated and recorded and a new averaging interval starts. Processed data are generated and recorded independently in 10 s time intervals within each averaging interval.

#### **Device Location ASL**

Enter the height of the MRR-2 location above sea level. The adjustable range is 0 ... 9999 m. This parameter is used for the density correction of the fall speed versus drop size relation.

#### **Height Resolution**

Enter the desired distance between adjacent measuring heights (step width).

The adjustable range is 10 – 1000 m. Typical values are 30 – 100 m.

The measuring heights are integer multiples of the height resolution. The maximum number of height steps is 31.

### Sampling Frequency

Number of samples per second of the analogue input signal of the MRR-2.  
This parameter can't be changed by the user.

### Calibration Constant

This constant is needed for converting the engineering units of the receiver signal (raw spectra) into physical units (processed and averaged data). See Physical Basis for details. The calibration constant is factory set. Nevertheless it can be changed by the experienced user. Before a new calibration constant can be entered the “changing” button must be pressed. It should be only done if there is clear evidence for a miss-calibration of the MRR. This can be inferred for example from rain rates measured with the MRR ( $R_{MRR}$ ) and a rain gauge ( $R_{RG}$ ) respectively. If  $C_{old}$  is the old calibration constant, the new calibration constant  $C_{new}$  can be calculated according

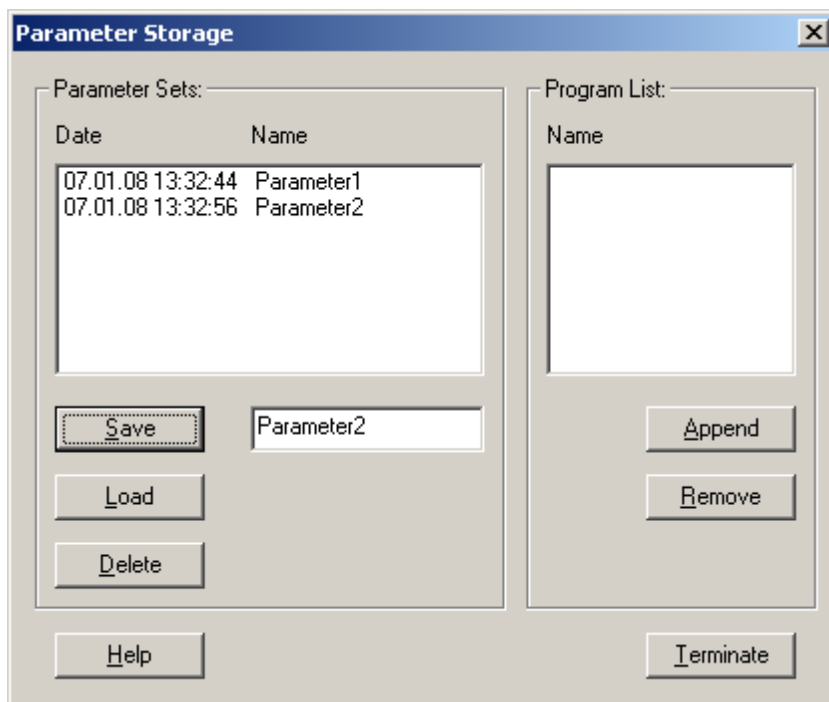
$$C_{new} = C_{old} \frac{R_{RG}}{R_{MRR}}$$

It should be kept in mind that comparisons of rain rates measured aloft with the MRR and a rain gauge are not straightforward due to the strong inhomogeneity of rain. MRR data should be taken from range gates not below the 3<sup>rd</sup> range gate because approximations in the radar equation cause larger biases at lower range gates. On the other hand the measuring height should not exceed 200 m in order to keep attenuation effects small (they are only eliminated in case of correct calibration) and to keep the correlation with surface precipitation at a useful level. Further make sure that the MRR rain retrieval is not affected by the ice phase or melting processes. Strong winds should also be avoided since rain gauges tend to be unreliable under such conditions.

### OK

All changes in the Device Parameters Menu become effective by clicking the “OK” button. Then the corresponding commands are transmitted to the RCPD firmware. Clicking the “Cancel” button cancels all changes.

### 7.3.5 Parameter Storage



**Figure 23: Parameter Storage**

#### Parameter Sets

The parameter memory of the MRR-2 is used for convenient saving and loading of complete parameter settings.

A parameter set consists of

- the device parameters (except calibration constant) and
- the selected output parameters

#### Saving a parameter set:

- Type a name in the field right of the **Save**-button or select a name of the Parameter Sets list.
- Click the **Save**-button.

#### Loading a parameter set:

- Type a name of the Parameter Sets list in the field right of the **Save**-button or select a name of the Parameter Sets list.
- Click the **Load**-button.

**Deleting a parameter set:**

- Type a name of the Parameter Sets list in the field right of the **Save**-button or select a name of the Parameter Sets list.
- Click the **Delete**-button.

**Program List**

Previously defined parameter sets can be added to a program list. All sets which are included in this list, will be processed successively. This means every time the averaging interval has finished, the next entry will be loaded from the list. After reaching the end of this list, the program starts over with the first entry.

**Creating a Program List**

- Select a parameter set in the Parameter Sets list
- Click the **Append** button. The parameter set is inserted in the empty Program List or added to the end of the non-empty Program List.

As soon as the Program List is not empty, it becomes active.

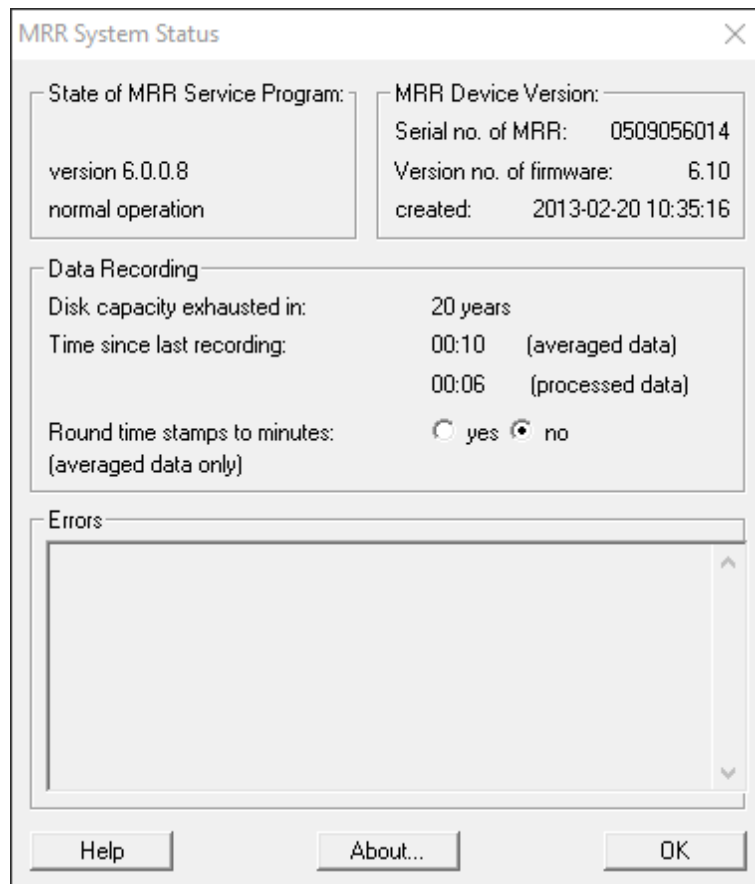
**Removing entries from the Program List**

- Select the entry from the Program List
- Click the **Remove**-button

**Note:**

1. Parameter sets which appear in the Program List can neither be changed nor deleted.
2. The same parameter set name may appear at several places in the Parameter List.

### 7.3.6 Status messages



**Figure 24: System Status**

#### **Sub-Panel: “State of the MRR Service Program”**

The version number of the MRR-Service is shown.

The operation state is shown:

- *normal operation*  
No problems occurred.
- *erroneous operation*  
It should appear if the COM Port couldn't be opened or the communication channel between Control Program and MRR-Service couldn't be established. The Control Program will terminate in both cases before this message can be displayed.

#### **Sub-Panel: “MRR Device Version”**

The serial number, the firmware version number and the firmware creation date of the connected MRR are shown.

**Sub-Panel: “Data Recording”**

- *Disk capacity exhausted in*  
The remaining time for data recording is shown. The calculation is based on the average sizes of the last received measuring protocol and the actual free disk space (Initially ??? appears until the first data set is stored).
- *Time since last recording*  
The time elapsed, since the last averaged and processed data sets were written to disk, is shown (Initially ??? appears until the first data set is stored).
- *Round time stamps to minutes*  
Time stamps are rounded to integer values. This can be useful under the following condition: If the "Adjust interval length to real time clock" (see chapter 7.3.2 **Control Commands Menu**) was selected, the time stamps should be integer multiples of 10 seconds, minutes or ten minutes. Nevertheless small deviations from these integers may occur due to variable processing time. If this is disturbing for subsequent data analysis programs, the recorded time stamps can be rounded. The selection *yes* or *no* is activated by pressing the *ok* button.

**Sub-Panel “Errors”**

This panel shows a list of errors which occurred during the measuring operation. Errors which occurred before the control program was started can be retrieved from the Windows® event log.

**About Button**

Version information about the control program appear if you press the “About” button.



## 7.4 Processed and averaged data

### 7.4.1 Format description

Processed and averaged data are archived in two separate directory structures (see chapter 8.1.2 Data Recording on page 54). Optional recording of so called raw spectra, which represent the unprocessed measuring data of the MRR-2, is possible.

Identifier	Meaning	Unit	Remark
MRR	<i>Header Line</i>	n.A.	
H	<i>Height</i>	m	
TF	<i>Transfer Function</i>	dimensionless	
$F_n$	<i>Spectral Reflectivities</i>	dB	$10 \cdot \log \eta_n$ with $\eta_n$ in $\text{m}^{-1}$ with $n$ from $n_{\min}(h)$ to $n_{\max}(h)$ See Physical Basics for boundaries of $n$ .
$D_n$	<i>Drop Size</i>	mm	Center of size class
$N_n$	<i>Spectral Drop Densities</i>	$\text{m}^{-4}$	$N(D_n)$ (see Physical Basics) (Metek Graphics:Version $\geq 2.30.1.10$ Plot available, but $10 \cdot \log_{10}(N_n)$ is displayed).
PIA	<i>Path Integrated Attenuation</i>	dB	(see Physical Basics)
Z	<i>Radar Reflectivity</i>	dBZ	$10 \log \left( 10^{-3} \sum_{n=n_{\min}}^{n=n_{\max}} \frac{N_n D_n^6 + N_{n-1} D_{n-1}^6}{2} (D_n - D_{n-1}) \right)^3$
z	<i>Attenuated Radar Reflectivity</i>	dBZ	Z and z are related by $z = Z - \text{PIA}$
RR	<i>Rain Rate</i>	$\text{mm h}^{-1}$	$6 \cdot 0,1887 \cdot 10^{-7} \pi \sum_{n=n_{\min}}^{n=n_{\max}} \frac{N_n D_n^3 + N_{n-1} D_{n-1}^3}{2} \left( n - \frac{1}{2} \right) (D_n - D_{n-1})$
LWC	<i>Liquid Water Content</i>	$\text{g m}^{-3}$	$10^{-6} \frac{\pi}{6} \sum_{n=n_{\min}}^{n=n_{\max}} \frac{N_n D_n^3 + N_{n-1} D_{n-1}^3}{2} (D_n - D_{n-1})$ <sup>4</sup>
W	<i>Fall Velocity</i>	$\text{m s}^{-1}$	$0,1887 \sum_{n=n_{\min}}^{n=n_{\max}} n F_n / \sum_{n=n_{\min}}^{n=n_{\max}} F_n$

<sup>3</sup> with  $N_{n_{\min}-1}$ ,  $D_{n_{\min}-1}$ , and  $F_{n_{\min}-1} = 0$

<sup>4</sup> Mass density of water is assumed to be  $10^6 \text{ gm}^{-3}$

The data format is human readable ASCII text. Each data set consists of one line. The order of the data lines and the used identifiers are listed below: The measured data are displayed in lines following the header. For each measured variable there is one line starting with a 3-character identifier of the variable. Each line represents a profile of this variable, i.e. a function versus height. Each data entry is 7 characters wide. Height is running from left to right in increments according to the chosen height resolution of the MRR. Invalid or not calculable values are coded as 7 consecutive space characters.

### **MRR – Header Line**

The header line marks the beginning of a data set. It starts with the identifying string "MRR", a space character and a date/time stamp. The date/time stamp consists of 12 digits (format *YYMMDDhhmmss*), a single space character and the name of the time zone. This name starts with the string „UTC“ and is optionally followed by an offset value (format *±hh* or *±hhmm*). The time stamp is generated from the PC time. Then several parameters follow:

- “AVE” **A**veraging time in seconds (“AVE”),
- “STP” height resolution in meters (“STP”),
- “ASL” height of the ground level **A**bove **S**ea **L**evel in meters (“ASL”),
- “SMP” **s**ampling rate of the RADAR signal in the time domain (unit: Hz),
- “SVS” version number of the MRR Service (service version number),
- “DVS” version number of the MRR firmware (device version),
- “DSN” serial number of the MRR (device serial number)
- “CC” calibration constant
- “MDQ” data quality parameter consisting of the identifying string. This number is the percentage of valid spectra collected during the averaging interval. Spectra can be invalid due to saturation of the AD converter – caused either by extreme precipitation or by some interference.
- “TYP” identifier for the kind of data: AVE-averaged data, PRO-processed data or RAW-raw spectra

Each of the parameters in the header line starts with a delimiting space character, the 3-character identifier as shown above in the parentheses and a field of 6 characters for the numerical value (except of the serial number, which can consist of up to 10 numeric characters between 0 and 9).

Example (Each entry of the header line is shown in a separate line of the table) :

MRR_110124040200_UTC	The header line dates from January 24th, 2011, 4:02 AM, timezone 'UTC'.
AVE_60	Averaging time is 60 seconds.
STP_35	Height resolution is 35 meters.
ASL_147	The radar is sited 147 meters above sea level.
SMP_125e3	Sampling rate is 125,000 Hz.
SVS_6.0.0.7	Version number of the MRR Service is 6.0.0.7
DVS_6.10	Version number of the MRR firmware is 6.10.
DSN_0502082121	Serial number of the MRR is 050208121.
CC_2066000	Calibration constant is 2066000.
MDQ_100	Percentage of valid spectra is 100
TYP_AVE	data are averaged data

## H - Height

Argument of the following data profiles corresponding to the settings described in chapter 7.3.3, page 33, and chapter 7.3.4, page 35. The units are meters above the radar system.

## TF - Transfer Function

To each height step a value of the Transfer Function is assigned by which raw spectra are divided.

## Fnn with nn from 0 to 63 - FFT Spectra

Each line represents a profile of spectral reflectivity corresponding to the spectral bin  $nn$ . As **Fnn** is corrected for the receiver noise floor negative values can occur, if the signal to noise ratio is low. These entries cannot be presented in the logarithmic domain and are replaced by space characters.

## Dnn with nn from min(h) to max(h) - Drop Sizes

The drop size is described by the diameter of an equivolumic sphere. The spectral bins of drop numbers are of variable width in the size domain (in contrast with spectral bins in the frequency- and velocity-domain). In addition, the widths of the size bins are slightly height dependent. Therefore the assignment of frequency-bin-index  $nn$  to diameter  $D$  is listed explicitly for each bin and height. The center of each size class is displayed.

**Nnn with nn from min(h) to max(h) - Spectral Drop Densities**

With the knowledge of the frequency of the Doppler-shift the calculation of the corresponding drop fall velocity is possible (equation 1.4.3.2 in MRR Physical Basics). Thus each FFT-line stands for a drop size interval. Chapter 2 in the Physical Basics shows how to derive from the received spectral power the number of drops for this drop size class, and finally – by division through the variable class width – the spectral drop densities.

Only a sub-set of all 64 spectral bins is considered for the calculation. The lower (min(h)) and upper limit (max(h)) depends on the height as described in MRR Physical Basics (Fig. 7).

In case of negative values of Fnn negative drop number densities are calculated. Although they have no physical meaning they are retained in order to avoid statistical biases.

**PIA - Path Integrated Attenuation**

The two-way Path integrated attenuation by rain drops is calculated as described in chapter 3.2 “MRR-Physical Basis” and is used for correction of Nnn, Z, RR and LWC.

**z - Attenuated Radar Reflectivity<sup>1)</sup>**

z is the radar reflectivity factor (see chapter 3.1 MRR-Physical Basics) without attenuation correction

**Z - Radar Reflectivity<sup>1)</sup>**

Z is the radar reflectivity factor (see chapter 3.1 MRR-Physical Basics)

**RR - Rain Rate<sup>1)</sup>**

RR is the rain rate (see chapter 3.3 MRR-Physical Basics)

**LWC - Liquid Water Content<sup>1)</sup>**

LWC is the liquid water content (see equation 3.2.1 MRR-Physical Basics)

<sup>1)</sup> *In case of low signal to noise ratio negative values can occur. Although they have no physical meaning they are retained in order to avoid statistical biases.*

**W - Fall Velocity**

W is the characteristic falling velocity.

(First Moment of the Doppler spectrum, see chapter 3.4 MRR-Physical Basics).

The width of velocity-bins can be derived from the maximum number of height steps, the sampling rate (as shown in the header line) and the wave length of the RADAR signal. 32 height steps and 64 lines per step are calculated. For a sampling frequency of 125 kHz and a transmit frequency of 24.23 GHz, the resolution of the fall velocity can be calculated as:

$$\frac{125 \text{ kHz}}{2} \frac{1}{32 \cdot 64} \frac{299700 \text{ km/s}}{2 \cdot 24.23 \text{ GHz}} = 0,1887 \text{ m/s}$$

### 7.4.2 Processed and averaged data example

**Processed and averaged data** files have the same structure including the header lines. Only the data type identifier “TYP PRO” resp. “TYP AVE” at the end of the header line is different.

```

MRR 110124085700 UTC AVE      60 STP    10 ASL      0 SMP 125e3 SVS 6.0.0.1 DVS 6.00 DSN
0200708021 CC 2079868 MDQ 100 TYP AVE
H      35      70      105      ...      1015      1050      1085
TF 0.0115 0.0420 0.0999 ...      0.6890 0.6406 0.4225
F00 -65.29 -74.53 -82.05 ...      -82.32 -87.28 -83.34
F01 -66.94 -76.22 -84.02 ...      -80.55 -85.48 -84.48
F02 -72.75 -81.78 -88.82 ...      -79.20 -84.64 -84.43
F03 -82.02 -88.54 -91.72 ...      -79.97 -85.73 -84.42
F04 -88.10 -89.28 -91.25 ...      -81.30 -87.44 -89.43
F05 -87.30 -88.16 -90.08 ...      -81.83 -92.29
F06 -86.28 -87.67 -89.08 ...      -81.55 -91.37
F07 -85.61 -87.55 -87.62 ...      -80.73 -86.27 -90.26
F08 -85.09 -86.74 -85.56 ...      -80.90 -83.80 -86.63
F09 -83.82 -85.29 -84.11 ...      -83.05 -86.41 -87.24
F10 -81.72 -83.85 -83.09 ...      -87.40      -86.95
F11 -80.23 -82.49 -81.94 ...      -84.87-101.37 -83.71
F12 -79.40 -81.17 -80.57 ...      -81.59 -86.14 -78.92
F13 -78.57 -79.85 -79.34 ...      -80.78 -81.78 -74.26
F14 -77.86 -78.66 -78.36 ...      -79.66 -76.73 -69.46
F15 -77.06 -77.59 -77.41 ...      -77.10 -71.53 -65.20
F16 -75.62 -76.37 -76.39 ...      -73.66 -66.92 -61.51
F17 -74.28 -75.27 -75.46 ...      -70.42 -63.54 -58.70
F18 -73.30 -74.28 -74.44 ...      -67.66 -61.18 -56.98
F19 -72.19 -73.25 -73.11 ...      -65.18 -59.40 -56.03
F20 -71.06 -71.94 -71.65 ...      -62.92 -57.99 -55.55
F21 -70.02 -70.51 -70.34 ...      -61.00 -56.68 -55.21
F22 -68.79 -69.29 -69.18 ...      -59.54 -55.98 -55.17
F23 -67.82 -68.28 -67.92 ...      -58.11 -55.69 -55.47
F24 -67.15 -67.36 -66.44 ...      -56.56 -55.26 -55.78
F25 -66.05 -66.05 -65.20 ...      -55.36 -54.98 -56.32
F26 -64.87 -64.49 -64.33 ...      -54.80 -55.01 -56.92
F27 -63.97 -63.27 -63.33 ...      -54.55 -55.34 -57.81
F28 -62.71 -62.26 -62.06 ...      -54.59 -55.99 -59.16
F29 -61.64 -61.26 -60.96 ...      -54.97 -57.05 -60.88
F30 -60.93 -60.35 -60.19 ...      -55.43 -58.37 -62.82
F31 -60.03 -59.37 -59.43 ...      -56.19 -59.79 -64.76
F32 -59.11 -58.53 -58.62 ...      -57.31 -61.23 -66.56
F33 -58.30 -57.67 -57.79 ...      -58.70 -63.05 -68.60
F34 -57.80 -56.89 -57.20 ...      -60.24 -65.50 -71.44
F35 -57.42 -56.24 -56.86 ...      -61.53 -67.89 -74.75
F36 -56.94 -55.77 -56.65 ...      -63.32 -70.14 -77.61
F37 -56.69 -55.63 -56.60 ...      -65.92 -73.07 -79.88
F38 -56.67 -55.72 -56.69 ...      -68.62 -76.39 -79.07
F39 -56.58 -55.70 -56.72 ...      -71.30 -79.54 -76.80
F40 -56.55 -55.55 -56.81 ...      -74.26 -83.17 -75.03
F41 -56.89 -55.67 -57.11 ...      -77.12 -85.09 -73.43
F42 -57.52 -56.04 -57.47 ...      -80.29 -87.09 -71.92
F43 -58.26 -56.73 -58.05 ...      -85.37 -86.62 -70.68
F44 -59.10 -57.69 -59.07 ...      -91.70 -83.35 -69.50
F45 -60.47 -58.85 -60.52 ...      -92.25 -81.10 -68.44
F46 -62.44 -60.31 -62.11 ...      -86.14 -80.06 -67.83
F47 -64.36 -62.11 -63.82 ...      -83.99 -79.82 -67.78
F48 -66.33 -64.24 -66.10 ...      -83.16 -79.51 -68.51
F49 -68.08 -66.65 -68.83 ...      -81.42 -79.59 -69.91
F50 -68.54 -68.91 -71.61 ...      -79.92 -78.87 -71.48
F51 -69.15 -71.09 -75.12 ...      -78.53 -78.05 -73.16
F52 -72.35 -74.64 -79.86 ...      -77.95 -78.44 -75.32
F53 -78.57 -80.07 -85.16 ...      -77.73 -79.02 -76.51
F54 -86.06 -86.09 -90.41 ...      -77.82 -78.91 -77.15
F55 -92.17 -93.58 -98.15 ...      -78.16 -78.58 -77.54
F56 -95.49-101.59-100.05 ...      -78.48 -78.98 -77.33
F57 -95.83-102.37-101.13 ...      -78.59 -79.24 -77.07
    
```

F58	-97.76	-109.34	...	-78.03	-79.33	-77.51	
F59	-101.35	-109.38	...	-77.11	-78.68	-78.96	
F60	-97.25	-98.23	-106.60	...	-76.41	-77.96	-79.56
F61	-85.64	-91.97	-96.80	...	-76.73	-78.26	-79.12
F62	-74.68	-83.22	-89.67	...	-77.84	-79.75	-80.12
F63	-67.85	-76.90	-84.03	...	-79.80	-82.65	-81.75
D00							
D01							
D02							
D03							
D04	0.2456	0.2454	0.2452	...	0.2404	0.2402	0.2400
D05	0.2817	0.2814	0.2812	...	0.2750	0.2748	0.2746
D06	0.3185	0.3182	0.3179	...	0.3104	0.3101	0.3098
D07	0.3562	0.3559	0.3555	...	0.3465	0.3462	0.3458
D08	0.3948	0.3944	0.3940	...	0.3835	0.3831	0.3827
D09	0.4343	0.4338	0.4334	...	0.4212	0.4208	0.4203
D10	0.4747	0.4742	0.4737	...	0.4599	0.4594	0.4588
D11	0.5162	0.5156	0.5150	...	0.4995	0.4989	0.4983
D12	0.5587	0.5580	0.5574	...	0.5400	0.5393	0.5386
D13	0.6023	0.6016	0.6008	...	0.5815	0.5808	0.5800
D14	0.6471	0.6463	0.6455	...	0.6241	0.6233	0.6225
D15	0.6931	0.6922	0.6913	...	0.6678	0.6669	0.6660
D16	0.7405	0.7395	0.7385	...	0.7127	0.7117	0.7108
D17	0.7892	0.7881	0.7870	...	0.7589	0.7578	0.7567
D18	0.8394	0.8382	0.8370	...	0.8063	0.8051	0.8040
D19	0.8911	0.8898	0.8886	...	0.8552	0.8539	0.8526
D20	0.9445	0.9431	0.9417	...	0.9055	0.9041	0.9027
D21	0.9997	0.9982	0.9967	...	0.9574	0.9559	0.9544
D22	1.0568	1.0551	1.0535	...	1.0109	1.0093	1.0077
D23	1.1159	1.1141	1.1123	...	1.0662	1.0645	1.0627
D24	1.1771	1.1752	1.1733	...	1.1235	1.1216	1.1197
D25	1.2407	1.2386	1.2365	...	1.1827	1.1807	1.1786
D26	1.3068	1.3046	1.3023	...	1.2442	1.2420	1.2398
D27	1.3757	1.3732	1.3708	...	1.3080	1.3056	1.3032
D28	1.4475	1.4449	1.4422	...	1.3743	1.3718	1.3692
D29	1.5226	1.5197	1.5168	...	1.4434	1.4406	1.4379
D30	1.6012	1.5980	1.5949	...	1.5155	1.5125	1.5095
D31	1.6836	1.6803	1.6769	...	1.5908	1.5876	1.5844
D32	1.7704	1.7668	1.7631	...	1.6697	1.6662	1.6627
D33	1.8620	1.8580	1.8540	...	1.7526	1.7488	1.7450
D34	1.9588	1.9545	1.9501	...	1.8397	1.8356	1.8315
D35	2.0617	2.0569	2.0521	...	1.9317	1.9272	1.9228
D36	2.1713	2.1661	2.1608	...	2.0291	2.0242	2.0193
D37	2.2887	2.2829	2.2771	...	2.1324	2.1271	2.1218
D38	2.4149	2.4085	2.4021	...	2.2427	2.2368	2.2310
D39	2.5515	2.5443	2.5372	...	2.3607	2.3542	2.3478
D40	2.7002	2.6922	2.6842	...	2.4877	2.4806	2.4735
D41	2.8636	2.8546	2.8455	...	2.6253	2.6173	2.6094
D42	3.0448	3.0344	3.0241	...	2.7752	2.7663	2.7574
D43	3.2480	3.2361	3.2242	...	2.9399	2.9298	2.9198
D44	3.4796	3.4655	3.4516	...	3.1227	3.1112	3.0998
D45	3.7485	3.7317	3.7149	...	3.3281	3.3148	3.3016
D46	4.0694	4.0485	4.0279	...	3.5623	3.5467	3.5312
D47	4.4672	4.4402	4.4135	...	3.8350	3.8162	3.7977
D48	4.9907	4.9530	4.9161	...	4.1612	4.1379	4.1149
D49	5.7582	5.6977	5.6392	...	4.5672	4.5369	4.5071
D50				...	5.1050	5.0624	5.0210
D51				...			5.7677
D52							
D53							
D54							
D55							
D56							
D57							
D58							
D59							
D60							
D61							
D61							
D62							
D63							
N00							

N01							
N02							
N03							
N04	1.7e+7	1.3e+7	8.3e+6	...	9.3e+7	2.3e+7	1.4e+7
N05	8.9e+6	7.3e+6	4.7e+6	...	3.6e+7	3.3e+6-5.7e+6	
N06	5.2e+6	3.8e+6	2.8e+6	...	1.8e+7	1.9e+6-2.7e+6	
N07	3.1e+6	2.0e+6	1.9e+6	...	1.1e+7	3.1e+6	1.3e+6
N08	1.8e+6	1.2e+6	1.6e+6	...	5.7e+6	3.0e+6	1.6e+6
N09	1.3e+6	964959	1.3e+6	...	1.9e+6	907918	754334
N10	1.3e+6	768728	923905	...	414979	-20941	465284
N11	1.0e+6	621685	711679	...	443056	9440.2	584411
N12	767281	512404	592273	...	577617	202885	1.1e+6
N13	576843	431121	488397	...	436064	347849	2.0e+6
N14	429862	359385	388558	...	360912	713077	3.8e+6
N15	333126	296551	311766	...	422713	1.5e+6	6.7e+6
N16	304136	257262	258238	...	616336	2.9e+6	1.0e+7
N17	274365	219690	212223	...	868205	4.3e+6	1.3e+7
N18	230314	184889	179919	...	1.1e+6	5.0e+6	1.3e+7
N19	200924	158461	165180	...	1.3e+6	5.1e+6	1.1e+7
N20	177710	146166	157718	...	1.6e+6	4.9e+6	8.7e+6
N21	155008	139360	146398	...	1.7e+6	4.6e+6	6.5e+6
N22	140816	126587	130999	...	1.6e+6	3.8e+6	4.6e+6
N23	121124	109708	120646	...	1.6e+6	2.8e+6	3.0e+6
N24	97263	93412	116639	...	1.6e+6	2.2e+6	1.9e+6
N25	86051	86804	106888	...	1.5e+6	1.6e+6	1.2e+6
N26	77397	85316	89612	...	1.2e+6	1.1e+6	727434
N27	65034	77233	77047	...	851860	718282	412021
N28	59026	66127	70259	...	584131	428478	209074
N29	50985	56198	61063	...	367922	231057	96781
N30	40194	46466	48851	...	225946	116619	42418
N31	32791	38667	38739	...	128777	57111	18438
N32	26779	30998	30818	...	67060	27643	8231.6
N33	21174	24803	24561	...	32615	12167	3448.5
N34	15543	19429	18430	...	15240	4622.4	1196.3
N35	11074	14746	13021	...	7517.4	1769.8	372.01
N36	8063.7	10718	8927.8	...	3299.7	699.22	127.95
N37	5579.9	7232.0	5896.5	...	1201.5	236.46	50.288
N38	3660.6	4631.9	3782.0	...	428.02	73.016	40.260
N39	2451.6	3052.0	2462.6	...	153.45	23.465	45.138
N40	1619.3	2074.6	1583.4	...	51.607	6.7670	45.100
N41	982.38	1326.3	973.26	...	17.781	2.8902	43.531
N42	559.59	801.97	590.94	...	5.7216	1.2082	41.131
N43	311.72	452.26	341.63	...	1.1879	0.9027	36.637
N44	169.68	239.35	178.44	...	0.1858	1.2911	32.235
N45	81.786	121.41	84.666	...	0.1087	1.4566	27.688
N46	34.401	57.447	38.938	...	0.2992	1.2458	21.402
N47	14.599	25.105	17.415	...	0.3312	0.8860	14.571
N48	6.0655	10.083	6.7792	...	0.2702	0.6419	8.2911
N49	2.5061	3.6136	2.2706	...	0.2706	0.4230	4.0321
N50				...	0.2527	0.3298	1.8604
N51				...			0.7945
N52							
N53							
N54							
N55							
N56							
N57							
N58							
N59							
N60							
N61							
N62							
N63							
PIA	0.000	0.028	0.054	...	0.743	0.833	0.939
z	32.52	33.54	32.65	...	33.37	33.36	33.33
Z	32.52	33.56	32.69	...	34.10	34.18	34.25
RR	2.93	3.25	3.09	...	12.16	16.29	20.79
LWC	0.17	0.18	0.17	...	0.76	1.07	1.49
W	6.57	6.73	6.57	...	5.11	4.61	4.16



## 7.5 Raw Spectra

### 7.5.1 Format Description

Each data block in a **raw spectra** file begins with a header line.

Example:

```
MRR 160519130211 UTC DVS 6.10 DSN 200708021 BW 37300 CC 2079868 MDQ 100 58 58 TYP RAW
```

<	Identifier for MRR data
160519130211	date/time stamp in format YYYYMMDDhhmmss
UTC	time zone information
DVS_6.10	Device version number (firmware)
DSN_200708021	Device serial number
BW_37300	Bandwidth
CC_2079868	Calibration constant
MDQ_100 58 58	Micro Rain Radar Data quality: percentage of valid spectra, number of valid spectra and number of total spectra
TYP_RAW	Identifier for data type (raw)

The next data lines contain the measuring heights. It begins with the capital letter H (H means height) and two space characters. The following numbers (9 digits decimal each) represent the measuring heights in meters.

The height line is followed by the line of the transfer function. It starts with the capital characters TF (Transfer Function) and one space character. The rest of that line represents the values of the transfer function for each height step (9 digits decimal each).

The line of the transfer function is followed by 64 data lines. Each one starts with the capital character F and a 2-digit number of the spectra line (0 to 63). The rest of these lines represent the received spectral signal power in engineering units for each height step (9 digits decimal each).

The raw spectra include the receiver noise floor.

## 7.5.2 Raw Spectra Example

```

MRR 090612024311 UTC DVS 6.00 DSN 0200708021 BW 37300 CC 2079868 MDQ 100 58 58 TYP RAW
H      0      35      70      ...      1015      1050      1085
TF 0.003292 0.011523 0.041975 ... 0.689026 0.640604 0.422497
F00  4798    2205    166    ...      6          6          4
F01  2780    1272    107    ...      8          7          5
F02  541     246     33     ...     10         8          6
F03   39     22     17     ...     11         8          6
F04   4       9      18     ...     12         9          6
F05   3       9      19     ...     12        11         7
F06   3       9      20     ...     13        12         7
F07   3       9      21     ...     12        12         7
F08   3      10     23     ...     10        11         6
F09   4      11     28     ...      9         10         6
F10   5      13     34     ...     12         9          5
F11   4      16     44     ...     14         8          4
F12   5      18     55     ...     13         7          4
F13   7      19     65     ...     13         6          5
F14   9      23     84     ...     15         9          6
F15  12      34    139     ...     17        12         7
F16  15      52    236     ...     19        12         8
F17  24      75    325     ...     22        12         7
F18  48     120    374     ...     23        12         7
F19  98     215    526     ...     25        15         9
F20  177    377    803     ...     29        19         11
F21  290    582   1054     ...     38        24         12
F22  492    873   1270     ...     48        31         16
F23  814   1437   1629     ...     61        40         22
F24  1103  2015   2193     ...     88        55         33
F25  1215  2304   3049     ...    130        81         48
F26  1202  2861   4088     ...    162       106         61
F27  1692  3945   4978     ...    200       124         79
F28  3428  4611   6013     ...    282       146         97
F29  6270  5873   8179     ...    355       166        105
F30  9754  9622  11394     ...    369       204        128
F31  13520 15729 15559     ...    331       251        187
F32  15274 23192 21914     ...    289       266        227
F33  13520 26471 25550     ...    276       245        176
F34  9754  21874 22408     ...    273       218        116
F35  6270  15310 16602     ...    237       211        110
F36  3428  9683  12461     ...    176       178        103
F37  1692  5905  11128     ...    119       114         68
F38  1202  4727  11416     ...     64        53         32
F39  1215  4582  11578     ...     25        21         16
F40  1103  4033  10911     ...     15        14         10
F41   814  3225  9611     ...     14        13          9
F42   492  2421  7508     ...     12        12          8
F43   290  1436  4351     ...     12        13          7
F44   177  675  2171     ...     13        14          8
F45   98   318  1386     ...     14        12          7
F46   48   149  828     ...     13        11          7
F47   24   60  332     ...     11        11          7
F48   15   21  96     ...     10        10          8
F49   12   10  33     ...     10         9          7
F50   9    8  19     ...     11        10          7
F51   7    7  14     ...     11        11          6
F52   5    7  12     ...     13        13          7
F53   4    6  11     ...     14        13          8
F54   5    8  13     ...     14        10          8
F55   4   10  15     ...     12         9          6
F56   3    9  15     ...     11        10          6
F57   3   10  19     ...     11         9          6
F58   3   11  24     ...      9         8          6
F59   3   10  24     ...     10         8          6
F60   4    9  21     ...     10        10          6
F61   39   25  18     ...     10        11          6
F62  541  254  29     ...     11        10          6
F63  2780 1279  95     ...     10         8          4

```

## 7.6 Removing of the Software

If you want to remove the program from your PC you must be logged in as administrator. If still active you must stop the MRR-Service using the services program in the program group control panel/Administrative Tools. Then activate the folder software, select the entry METEK MRR Software and press the button Add/Remove. Finally you must manually remove the empty directory (C:\METEK) and possibly some data files and directories.



## 8 Detailed description of the MRR-2 control program

The MRR-2 generates Doppler spectra at 31 height ranges. The data processing is performed by a DSP which is located in the Radar Control and Processing Device (RCPD) at the antenna. The measured data are transmitted by a serial RS-422 port, in the Junction Box this signal is converted to RS232 level. This port is also used for the device control. If the MRR-2 is connected to a PC, the control, the calculation of further values and the recording of the data can be done with the MRR-2-control program described below.

The software is divided into two components :

- MRR-Service
- Control Program

The MRR-Service communicates directly with the connected MRR-2 and the Control program performs the operational control of the MRR-2 using the MRR-Service. By means of this the user can interrogate or change the system status in a comfortable way.

### **Windows® Service Programs**

Service programs are software components which are started automatically when the machine is turned on and the operating system boots. They offer their 'services' e.g. control functions and data to other programs. The management of those programs must be provided by the operating system. The starting of a service program needs no manual operation. Only take care that the corresponding service is not deactivated.

Various details of the usage of services depend on the operating system. For this reason the used operating system should be Windows® 2000 or XP. (Windows® Vista and Windows 7 are supported with some limitations).

## 8.1 MRR-Service

The MRR-Service has three functions:

- Communication
- Data recording
- Error handling

### 8.1.1 Communication

This function of the MRR-Service is needed for the communication between the Control-Program and the MRR-2, for communication a serial interface (RS232 / RS422) is used. With the Control Program the system settings of the MRR-2 can be retrieved and any changes entered by the user are translated to the corresponding commands and transmitted to the MRR-2. (Factory setting of the serial port of the MRR-2 is 57600 baud, 8 bit, no parity, Xon/Xoff handshake protocol.)

### 8.1.2 Data Recording

The second function of MRR-Service is the recording of the “averaged” or “processed” measured data of the MRR-2. The data is ASCII formatted, so that it is directly readable.

The MRR-Service creates one file each day, whose name is constructed from the actual month, the day (2 characters each) and an additional extension. The boundary between two days is defined as 0:00 (selected time zone including UTC). The file name extension is `.ave` for averaged data and `.pro` for processed data.

All files of a month are stored in a separate directory which will be created automatically if it does not already exist. The names of the directories are constructed from the actual year (4 digits) and the respective month (2 digits).

The path names for the data registration and the port settings may be changed with the MS registry editor `regedit.exe` at the key

```
HKEY_LOCAL_MACHINE\  
  System\  
    CurrentControlSet\  
      Services\  
        MrrSrvc\  
          Parameters
```

The variables of this key are shown with their default settings. Change the underlined values, if necessary :

Port	REG_SZ	<u>COM1</u>
BaudRate	REG_DWORD	57600
AveExtension	REG_SZ	<u>.ave</u>
AveragedDataFile	REG_EXPAND_SZ	<u>C:\Metek\ActData\AveData%s</u>
AveragedDataPath	REG_EXPAND_SZ	<u>C:\Metek\AveData</u>
ProExtension	REG_SZ	<u>.pro</u>
ProcessedDataFile	REG_EXPAND_SZ	<u>C:\Metek\ActData\ProcessedData%s</u>
ProcessedDataPath	REG_EXPAND_SZ	<u>C:\Metek\ProcessedData</u>
RawExtension	REG_SZ	<u>.raw</u>
RawSpectraFile	REG_EXPAND_SZ	<u>C:\Metek\ActData\RawSpectra%s</u>
RawSpectraPath	REG_EXPAND_SZ	<u>C:\Metek\RawSpectra</u>

The common root directory is defined by the environmental variable

MetekRoot

It also can be changed with the registry editor at the following key :

```
HKEY_LOCAL_MACHINE\
  System\
    CurrentControlSet\
      Control\
        Session Manager\
          Environment
```

The variable is :

MetekRoot	REG_SZ	C:\METEK
-----------	--------	----------

The default settings are :

C:\METEK\ActData	for actual data (raw, processed and averaged)
C:\METEK\AveData	for averaged data
C:\METEK\ProcessedData	for processed data
C:\METEK\RawSpectra	for raw spectra

The file C:\METEK\AveData\201201\0106.ave e.g. would contain the averaged data from January, 6<sup>th</sup> of 2012.

### 8.1.3 Error Handling

The third function of the MRR-Service is the recording of all error messages which are caused by the operation of the MRR-2 (except messages which are generated from user input errors).

The error recording is done by the event logging function of the operation system. At the item `application` you find a chronologically sorted list of error messages which occurred during the operation. Use the Windows event viewer to look at the messages or to store them in other formats. You also can define how the system shall act if more than the storable number of errors occurs. The event viewer is located in the program group `Programs/Administrative Tools`.



## 8.2 Control Program

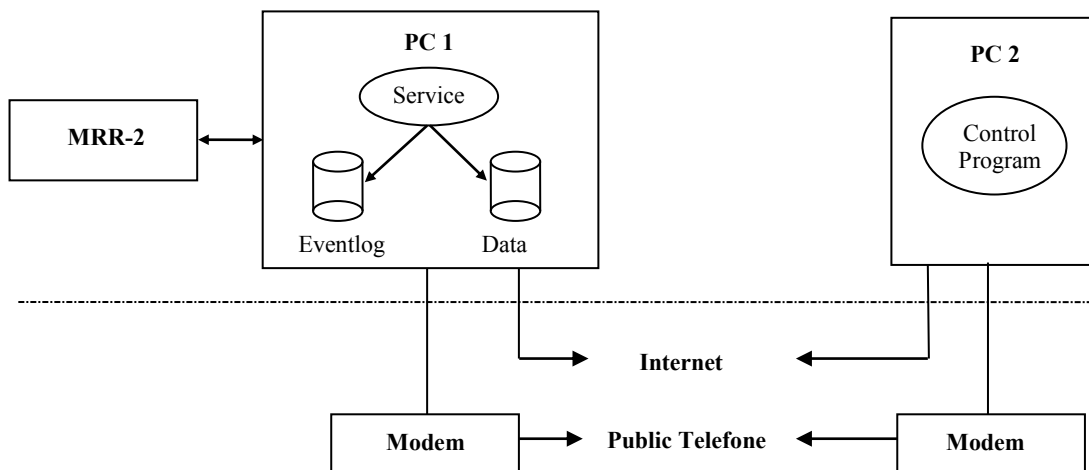
The Control Program provides the user access to the MRR-2 through the MRR-Service. The correct installation and the automatic start of the service program are required for a successful start of Control Program. The Control Program allows controlling the MRR-2 also by PCs which are not connected directly to the MRR-2.

It is necessary that there is a network connection to that PC on which the MRR-Service was started. This network connection may be either a local connection (LAN, Ethernet) or a remote access connection (RAS) which is built up using the Internet or public telephone.

For this remote operation a login at the remote MRR-Service is necessary when you start the program. This ensures that only one user is accessing the MRR-2.

There are no special network installations needed because no network protocol dependent functions are used between the service and the user interface.

The following picture shows an example for a remote access where the network connection is performed by a RAS connection. The Control Program on PC #2 uses the network and the MRR-Service on PC #1 to communicate with the MRR-2. The data recording and the event logging is executed on PC #1 which is connected directly to the MRR-2:



**Figure 25: Remote Acces**

The software is supplied on a USB-Stick with the following file:

MRRSetup\_V6007.exe            the setup program

After installation of the MRR software the port settings may be changed with the MS registry editor regedit.exe at the key

```
HKEY_LOCAL_MACHINE\  
  System\  
    CurrentControlSet\  
      Services\  
        MrrSrvc\  
          Parameters
```

The port variables of this key are shown with their default settings. Change the underlined values, if necessary :

Port	REG_SZ	<u>COM1</u>
BaudRate	REG_DWORD	<u>57600</u>

(You must be logged in with administration rights to change Windows® Registry parameters)

Every time when you change one or more MRR parameters in the Windows® Registry you have to restart the MRR service because these parameters are only read from the Registry when the service starts.

Open the

Start/Settings/Control Panel/Administrative Tools/Services - menu in Windows® 2000. After selecting the MRRService, stop and start it directly with the short cuts or open the **Properties menu** and use the **Stop** and **Start** buttons.

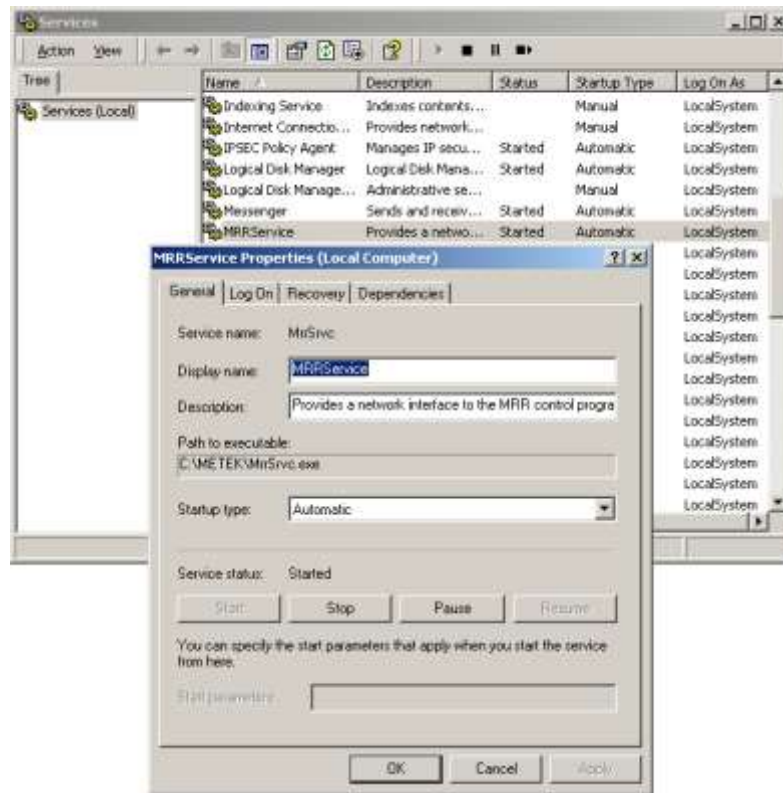


Figure 26: Administrative Tools / Services – Menu (Windows® 2000)

## 9 MRR-2 Specifications

### RCPD with Radar module

Operating Frequency:	24.230 GHz
Operating Mode:	FMCW
Modulation:	0.5 - 15 MHz
Output Power:	50 mW (+17 dBm) (antenna foot point)
OoB and Spurious Emission:	< -80 dBm/MHz (antenna foot point)
2 <sup>nd</sup> Harmonic:	-37 dBm
ITU-Designation:	40M0F3N
Power Supply:	24 VDC / 1A

### Antenna

Type:	parabolic offset antenna
Diameter:	600 mm
3 dB Beamwidth:	approx. 1.5 °
Gain:	40.1 dBi

### Junction Box / Power Supply:

Input Voltage:	115 or 230 VAC (50 .. 60 Hz)
Output Voltage	24 VDC / 1.5 A
Dimensions:	270 x 170 x 100 mm
Weight:	4 Kg

### Antenna Heating (Option)

Power Supply:	115 or 230 VAC (50 .. 60 Hz)
Power Output:	approx. 500 W

### Complete System:

Weight:	17.5 Kg
Dimensions:	800 x 600 x 850 mm

# CETECOM ICT Services GmbH

EC Identification number 0682

authorized by the German Government



to act as Notified Body in accordance with the R&TTE Directive 1999/5/EC of 09. March 1999.

## CERTIFICATE EXPERT OPINION

Registration-No.: E814169R-EO  
 Certificate Holder: METEK  
 Meteorologische Meßtechnik GmbH  
 Fritz-Straßmann-Str. 4  
 D-25337 Elmshorn  
 Product Designation: Mikro-Regen-Radar (MRR) / PreWeS24  
 Product Description: Radar System  
 Product Manufacturer: METEK  
 Meteorologische Meßtechnik GmbH  
 Fritz-Straßmann-Str. 4  
 D-25337 Elmshorn

Essential requirements	Specifications / Standards	Submitted documents	Result
Radio spectrum (R&TTE, Article 3.2)	EN 300 440-1 V1.3.1 (2001-09) EN 300 440-2 V1.1.1 (2001-09)	Test Report	conform

Marking: The product shall be signed with CE, our notified body number and the Class II identifier (Alert sign) as shown right hand.



The scope of this evaluation relates to the submitted documents only.  
 The certificate is only valid in conjunction with the following number of annexes:

Number of annexes: 1

Saarbrücken, 18.10.2004  
 Place, Date of Issue

Signed by Ernst Hussinger  
 Notified Body



CETECOM ICT Services GmbH, Untertürkheimer Straße 6-10, D-66117 Saarbrücken, Germany  
<http://www.cetecom.de>

## 10 Manual Revisions

In order to support the efficient use of our manuals a table of manual revisions has been added which lists all changes applied to the relevant documents.

In case of a support request regarding usage or content of a manual pls. let us know which manual release has been delivered with the system you are operating.

Manual version released	Manual version replaced	Modif. parts	Correction: C Addition: A	Modification: M Deletion: D	Current SW version
MRR-2 2014-03-07	MRR-2 2013-02-25	ch. 5  ch 6.3  all ch	A: Heavy Duty case, Pictures A: Heater Connection Box, Pictures		PC 6.0.0.6 FW 6.10
MRR-2 2015-11-06	MRR-2 2014-03-07	All	C: many typing errors removed		PC 6.0.0.6 FW 6.10
MRR-2 2016-05-20	MRR-2 2015-11-06	All	M:Software Version 6.0.0.7, screenshots updated, CD-ROM-> USB-Stick A: Windows 10 C: typing errors removed		PC 6.0.0.7 FW 6.10
20160802	2016-05-20	All	M:Software Version 6.0.0.8, screenshots		PC 6.0.0.8 FW 6.10