

Operation and Maintenance Manual

For the

IMET-3050A 403 MHz GPS UPPER-AIR SOUNDING SYSTEM

Unclassified

Prepared For

GENERAL DISTRIBUTION

by

INTERNATIONAL MET SYSTEMS

4767 Broadmoor Ave. SE Suite 7
Grand Rapids, MI 49512
U.S.A.

Commercial Entity Code: 1NG75

06 December , 2019

PROPRIETARY DATA RESTRICTION – This document contains information which is proprietary to International Met Systems. It shall not be disclosed outside the government without written permission of International Met Systems. This restriction does not limit the government’s right to use information contained in this document, if it is obtained from another source without restriction. The information subject to this restriction is contained on sheets marked “Use or disclosure of this information is subject to the restriction on the cover page of this document.”

RECORD OF CHANGES

Change No.	Date	Title or Brief Description	Entered by
14	December 06, 2019	Fixed some minor mistakes and updated figure 2-2 and 3-15	MDB
13	October 16, 2018	Added the iMet-4 as the primary radiosonde	MDB
12	April 17, 2016	Format clean-up	FAC
12	September 21, 2016	Added some sections to Ch. 3 for COM ports	MDB
11	July 29, 2014	General Updates	JHM
10	July 15, 2014	Initial Release	JPB

TABLE OF CONTENTS

CHAPTER 1 INTRODUCTION	1-1
1.1 403 MHz Omni-Directional Antenna	1-2
1.2 403 MHz Receiver Assembly	1-2
1.2.1 GPS Antenna/Receiver Module	1-2
1.2.2 Low-Noise Amplifier (LNA)	1-2
1.2.3 403 MHz Receiver	1-2
1.2.4 Radiosonde Decoder	1-2
1.3 Antenna Tripod	1-3
1.4 403 Power-Comms Cable	1-3
1.5 PSU/Data ConvertEr Unit	1-3
1.6 403 PC USB Data Cable	1-3
CHAPTER 2 ADDITIONAL COMPONENTS REQUIRED FOR FLIGHT	2-1
2.1 Radiosonde	2-1
2.1.1 General	2-1
2.1.2 Shipping and Storage	2-1
2.1.3 Operation	2-2
2.2 Balloons	2-2
2.2.1 General	2-2
2.2.2 Balloon Specifications	2-2
2.2.3 Storage	2-3
2.3 String/De-Reeler	2-3
2.3.1 String	2-3
2.3.2 De-Reeler	2-3
CHAPTER 3 SYSTEM SETUP	3-1
3.1 Installation Checklist	3-1
3.2 Setup Procedure	3-2
3.2.1 Connecting the Hardware	3-2
3.2.2 Connect to the Computer	3-2
3.2.3 COM Port Recognition	3-2
3.3 Basic Setup of iMetOS-II	3-3
3.3.1 Hardware Requirements	3-3
3.3.2 Installation	3-4
3.3.3 Configuring iMetOS-II	3-4
3.3.3.1 Communications	3-4
3.3.3.2 Other Tabs	3-5
3.4 Launch Sequence	3-5
3.4.1 Activate the iMet-3050A and System Computer	3-5
3.4.2 Start iMetOS-II and Log in if Required	3-6
3.4.3 Load a New Sounding	3-7
3.4.4 Prepare the iMet-4 Radiosonde	3-8

3.4.5 Finishing Sounding Setup	3-8
3.4.6 Inflate the Balloon and Assemble the Flight Train	3-12
3.4.7 Release Balloon	3-13
3.4.8 Flight Status Check	3-13
3.4.9 Messages and Graphs	3-14
3.4.10 Flight Termination	3-14
3.4.11 Report Sending and Archiving	3-14
CHAPTER 4 ROUTINE MAINTENANCE.....	4-1
4.1 General	4-1
4.2 Yearly Maintenance – Outdoor Equipment.....	4-1
4.2.1 Antenna Connector	4-1
4.2.2 Antenna.....	4-1
4.2.3 Secure Mounting.....	4-1
4.2.4 Data Cable	4-1
4.3 Indoor Equipment.....	4-1
CHAPTER 5 LRU REMOVAL/ REPLACEMENT.....	5-1
5.1 General	5-1
5.2 Line Replaceable Units	5-1
CHAPTER 6 TROUBLESHOOTING.....	6-1
6.1 Introduction	6-1
6.2 Troubleshooting Tables	6-1
6.2.1 Hardware.....	6-1
6.2.2 Software.....	6-1
6.3 Checkout Procedures	6-2
6.3.1 Communications Checkout.....	6-2
6.3.2 Radiosonde Checkout	6-3
6.3.3 Receiver Tuning Checkout	6-3
CHAPTER 7 CONTACTING SUPPORT	7-1
7.1 Identifying Problems	7-1
7.2 Means of Contact.....	7-1
7.3 Sending Data	7-1

INDEX OF FIGURES

Figure 1-1: iMet-3050A	1-1
Figure 1-2: iMet-3050A Block Diagram	1-2
Figure 2-1: iMet-4 Radiosonde	2-1
Figure 2-2: De-Reeler (International Met Systems).....	2-3
Figure 3-1: 3050A system components	3-1
Figure 3-2: Driver Error	3-2
Figure 3-3: Driver Installation Folder	3-2

Figure 3-4: Device Manager	3-3
Figure 3-5: System Setup	3-4
Figure 3-6.....	3-5
Figure 3-7 User Log In	3-6
Figure 3-8: Sounding Setup	3-7
Figure 3-9: New Sounding Name	3-7
Figure 3-10: Step Completed	3-8
Figure 3-11: Select Radiosonde	3-9
Figure 3-12: Station Details	3-10
Figure 3-13: Radiosonde Data	3-11
Figure 3-14: Current Weather	3-12
Figure 3-15: Radiosonde Flight Train.....	3-13
Figure 3-16: Flight Termination	3-14
Figure 3-17: Sounding Management.....	3-15

INDEX OF TABLES

Table 1-1: List of Abbreviations and Captions	vii
Table 2-1: Radiosonde Storage Requirements	2-2
Table 2-2: Balloon Specifications	2-2
Table 5-1: iMet-3050A Line Replaceable Units	5-1
Table 6-1: Hardware Troubleshooting	6-1
Table 6-2: Cable Pinout	6-1
Table 6-3: Software Fault Isolation	6-1
Table 6-4: Communications Checkout	6-2
Table 6-5: Radiosonde Checkout	6-3
Table 6-6: Receiver Tuning Checkout	6-3

FOREWORD

PURPOSE

The purpose of this manual is to provide the information required to and operate the iMet-3050A Upper Air Sounding System and the iMetOS Meteorological Operating System.

SCOPE

This Manual describes the characteristics and operating procedures for using the iMetOS-II and iMet3050A. Included is information on the following topics:

CHAPTER 1 – Introduction

CHAPTER 2 – Additional Components Required for Flight

CHAPTER 3 – System Setup

CHAPTER 4 – Routine Maintenance

CHAPTER 5 – LRU Removal/Replacement

CHAPTER 6 – Troubleshooting

CHAPTER 7 – Contacting Support

Information about the operations of the System Computer and System Printer (if supplied) is available in the Manufacturer's Documentation and is not covered in this Manual.

More detailed information about the iMetOS-II software package is available as document 200,850 provided by International Met Systems

Table 1-1: List of Abbreviations and Captions

Abbreviation	Explanation
AFC	Automatic Frequency Control
C	Celsius
COM	Communication
CPU	Central Processing Unit
dB	Decibel
dBm	Decibels relative to 1 milliwatt
DC	Direct Current
MHz	Mega Hertz
GPS	Global Positioning System
USB	Universal Serial Bus
UTM	Universal Transverse Mercator
VDC	Volts Direct Current
kg	Kilogram
PSU	Power Supply Unit
LRU	Lowest Replaceable Unit
RF	Radio Frequency
MSL	Mean Sea Level

SAFETY SUMMARY

GENERAL SAFETY INSTRUCTIONS

This manual describes physical processes that may cause injury or death to personnel, or damage to equipment if proper procedures are not followed. General safety precautions and instructions must be understood and applied during operation and maintenance to ensure personnel safety and protection of equipment. Prior to performing any task, all WARNINGS, CAUTIONS and NOTES applicable to the task shall be reviewed and understood.

WARNINGS, CAUTIONS AND NOTES

WARNINGS and CAUTIONS are used in this manual to highlight operating or maintenance procedures, practices, conditions or statements that are considered essential for the protection of personnel (WARNING) or equipment (CAUTION). WARNINGS and CAUTIONS immediately precede the step or procedure to which they apply. WARNINGS and CAUTIONS consist of four parts: heading (WARNING or CAUTION), a statement of the hazard, minimum precautions, and possible result if disregarded. A NOTE is used in this manual to highlight operating or maintenance procedures, practices, conditions or statements that are not essential to the protection of personnel or equipment. A NOTE may precede or follow the step or procedure, depending upon the information to be highlighted. The headings used and their definitions are as follows.

WARNING

Highlights an essential operating or maintenance procedure, practice, condition, statement, etc., which if not strictly observed, could result in injury to, or death of, personnel or present a long-term health hazard.

CAUTION

Highlights an essential operating or maintenance procedure, practice, condition, statement, etc., which if not strictly observed, could result in damage to, or destruction of, equipment or loss of data.

NOTE

Highlights an essential operating or maintenance procedure, condition, or statement.

CHAPTER 1 INTRODUCTION

As described in this Manual, the iMet-3050A consists of the following components:

1. 403 MHz Omni-Directional Antenna and Receiver Assembly
2. 403 Power-Comms Cable
3. PSU/Data Converter
4. USB Cable
5. Tripod

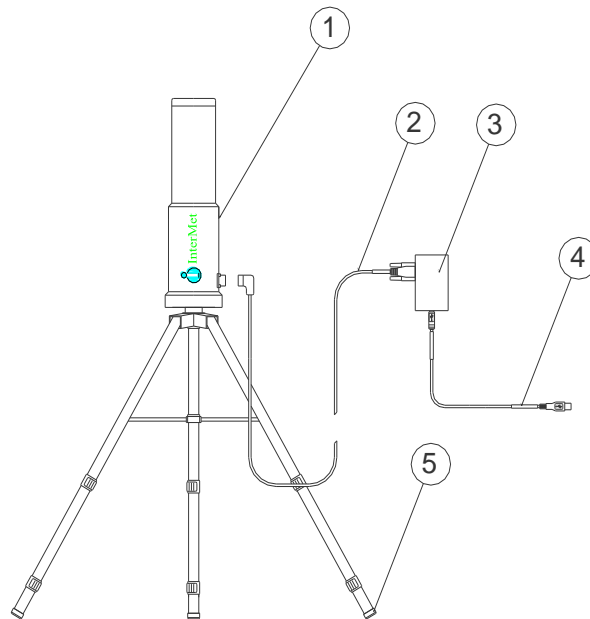

Figure 1-1: iMet-3050A

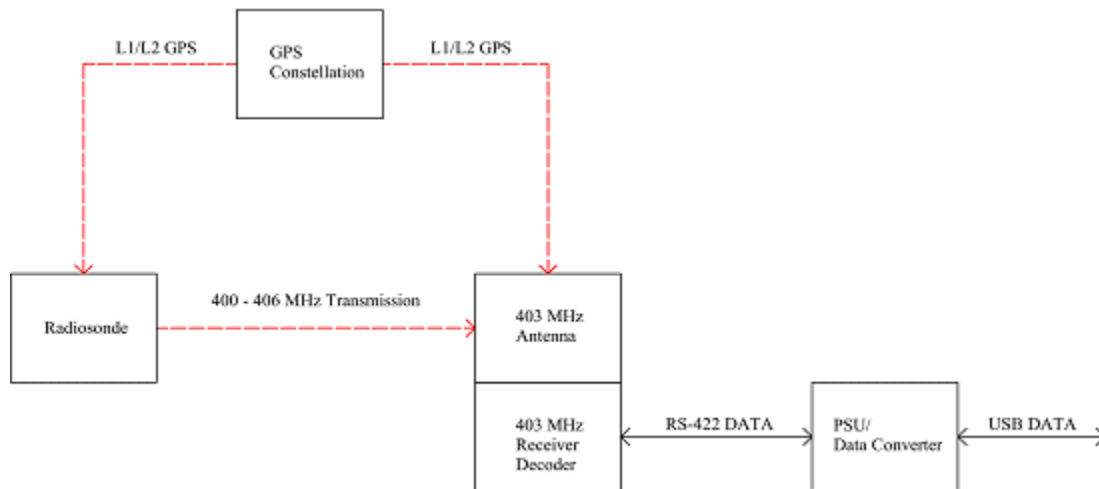

Figure 1-2: iMet-3050A Block Diagram

1.1 403 MHZ OMNI-DIRECTIONAL ANTENNA

The antenna is optimized for the 400 MHz to 406 MHz transmission band. It is a dipole antenna.

1.2 403 MHZ RECEIVER ASSEMBLY

The receiver consists of several components that receive and decode both the radiosonde and GPS data.

1.2.1 GPS Antenna/Receiver Module

The GPS Antenna Receiver module consists of a patch antenna and SkyTraq GPS receiver. Once the receiver has acquired a lock with four satellites, it begins transmitting the positional information to the system computer using the RS-422 data line.

1.2.2 Low-Noise Amplifier (LNA)

The signal coming from the antenna is immediately amplified through a front-end amplifier (LNA) with a gain of 16 dB. This amplifies the 400 MHz to 406 MHz band in order to increase the overall gain of the system.

1.2.3 403 MHz Receiver

The 403 MHz Receiver operates in the 400 MHz to 406 MHz frequency range. This converts the transmission of the radiosonde into baseband audio data for processing.

The receiver is a narrow-band receiver operating with a bandwidth of 6 kHz.

The receiver has built-in scanning and automatic frequency control (AFC) features to limit the amount of user interaction necessary.

The receiver is controlled and monitored using the RS-422 data line.

1.2.4 Radiosonde Decoder

The 403 MHz Receiver Assembly includes a built-in audio decoder, which translates the baseband audio from the receiver into RS-422 data.

1.3 ANTENNA TRIPOD

The Antenna tripod provides mounting for the 403MHz Antenna and is designed for mobile applications.

1.4 403 POWER-COMMS CABLE

The 403 Power-Comms cable provides an RS-422 link between the 403 MHz Receiver and the PSU/Data Converter Unit.

1.5 PSU/DATA CONVERTER UNIT

The PSU/Data Converter unit provides power to the system.

1.6 403 PC USB DATA CABLE

The 403 PC USB Data Cable connects the PSU/Data Converter Unit to the customer supplied System Computer. This is a standard USB cable.

CHAPTER 2

ADDITIONAL COMPONENTS REQUIRED FOR FLIGHT

The following items are required for all radiosonde flights:

1. Radiosonde
2. Balloon
3. De-Reeler/String

2.1 RADIOSONDE

2.1.1 General

The iMet-3050A operates with the iMet-4 Radiosonde (Figure 2-1) and legacy radiosondes such as the iMet-1 and iMet-2.



Figure 2-1: iMet-4 Radiosonde

The iMet-4 radiosonde measures the pressure, temperature, and humidity. It also contains a GPS receiver for location and calculating wind velocity and direction. It transmits the data at a rate of one packet per second. It can transmit at seven discrete frequencies, selectable by a push-button switch that is accessible on the front of the radiosonde.

2.1.2 Shipping and Storage

The radiosonde may be taken out of the cardboard shipping container upon arrival for storage purposes, but each individual radiosonde should remain in the sealed plastic bag until a flight is performed.

The radiosondes should be stored according to the conditions listed in

Table 2-1.

Table 2-1: Radiosonde Storage Requirements

Air Temperature:	-50.0°C to +60.0°C
Air RH:	5.0 percent to 100.0 percent (non-condensing)
Altitude:	-50.0 m to 3.0 km, MSL

2.1.3 Operation

The instructions for operating the radiosonde are located on outside sleeve. Typically, the radiosonde only takes 1-3 minutes to prepare for flight.

2.2 BALLOONS

2.2.1 General

Weather balloons are used to carry the radiosonde into the atmosphere. They are typically filled with either Hydrogen or Helium gas.

Most weather balloons are made of latex, and they come in various sizes.

2.2.2 Balloon Specifications

Some typical balloon sizes and specifications are show in Table 2-2 from a balloon manufacturer.

Table 2-2: Balloon Specifications

	Sounding Balloons									
Reference	KCI 200	KCI 300	KCI 350	KCI 450	KCI 500	KCI 600	KCI 700	KCI 800	KCI 1000	
Color	uncolored									
Average Weight (gr)	200	300	350	450	500	600	700	800	1000	
Neck Diameter (cm)	3	3	3	3	3	3	3	3	3	
Neck Length (cm)	12	12	12	12	12	12	12	12	12	
Flaccid Body Length more(cm)	86	108	118	125	143	157	171	184	206	
Barely Inflated Diameter more(cm)	55	69	75	86	91	100	109	117	131	
Payload (gr)	250	250	250	250	250	250	250	250	250	
Recommended Free Lift (gr)	510	560	585	635	655	870	920	970	1060	
Nozzle Lift (gr)	760	810	835	885	905	1120	1170	1220	1310	
Gross Lift (gr)	960	1110	1185	1335	1405	1720	1870	2020	2310	
Diameter at Release (cm)	117	123	125	130	133	142	146	150	157	
Volume at Release (cu. m)	0.83	0.97	1.03	1.1	1.22	1.5	1.63	1.76	2.01	
Rate of Ascent (m.min)	320	320	320	320	320	320	320	320	320	
Diameter at Buret (cm)	300	378	412	472	499	602	653	700	786	
Bursting Altitude (km)	21.2	24.7	25.9	27.7	28.4	30.8	31.8	32.6	33.9	
Bursting Pressure (hPa)	45.3	26.3	21.9	16.6	14.9	10.4	8.9	7.6	6.6	

It is important to follow the specifications of the balloon manufacturer if the bursting altitude is to be maximized.

2.2.3 Storage

Several factors affect balloon performance, and balloon degradation due to storage is minimal. They should, however, be kept near the radiosondes under similar storage conditions.

2.3 STRING/DE-REELER

Either a string or de-reeler is used to attach the radiosonde to the weather balloon.

2.3.1 String

String may be used to attach the radiosonde to the weather balloon. The operator should use at least 30 meters of string between the radiosonde and the balloon. There are two reasons that the string should be at least 30 meters:

- 1.) The radiosonde is further away from the balloon so that the sensors are not as affected by the wake of the balloon.
- 2.) The radiosonde does not rotate (like a pendulum) with as much intensity – which could affect GPS position and wind information.

The string is typically made of cotton twine (or similar material), and is purchased separately from the radiosondes.

2.3.2 De-Reeler

A de-reeler may be used in place of the string (See Figure 2-2).

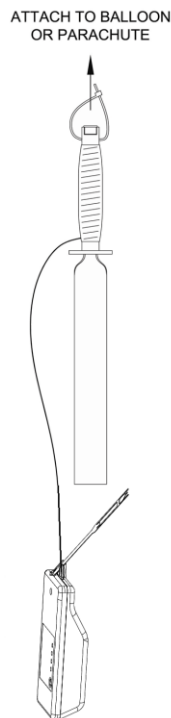

Figure 2-2: De-Reeler (International Met Systems)

The de-reeler is used to attach the radiosonde to the balloon with a pre-cut string. It automatically unwinds the string. These are the advantages to having a de-reeler:

- 1.) There is no need to cut or measure string.
- 2.) In high winds, the string will not become tangled around nearby objects.
- 3.) Each de-reeler is packed individually for storage.

Details on how to use the de-reeler for a flight are found in Section 3.4.6.

CHAPTER 3 SYSTEM SETUP

3.1 INSTALLATION CHECKLIST

The iMet-3050A components are shown in Figure 3-1.

1. 403 MHz Omni-Directional Antenna and Receiver Assembly
2. 403 Power-Comms Cable
3. PSU/Data Converter
4. USB Cable
5. Tripod

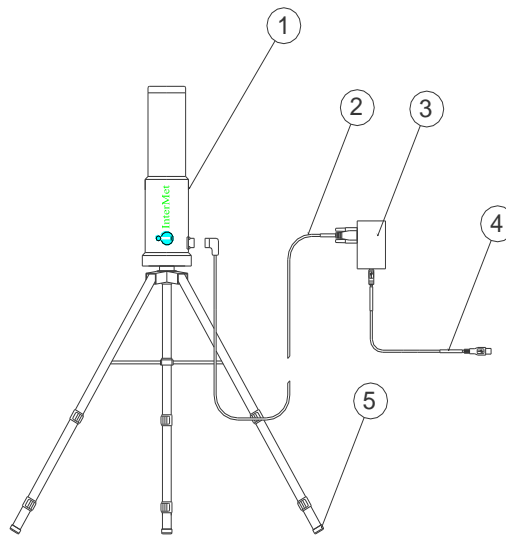

Figure 3-1: 3050A system components

3.2 SETUP PROCEDURE

3.2.1 Connecting the Hardware

Remove the tripod (5) from the case and place into position. Mount the antenna (1) onto the tripod and secure with center bolt. Connect the 403 Power-Comms Cable (2) to the antenna and to the PSU/Data Converter (3). Connect the USB Cable (4) to the PSU/Data Converter.

NOTE

Select a location that is high and clear of RF obstructions, including trees, for best reception. Avoid locations between buildings or near trucks and automobiles. Stay a safe distance away (100 m) from overhead electrical wires.

NOTE

The antenna must be placed within 30 meters of the shelter so that it does not exceed the length of the 403 Power-Comms Cable.

3.2.2 Connect to the Computer

Start the computer and insert the installation CD. Once the computer is fully started, plug the USB Cable (4) into the Computer.

3.2.3 COM Port Recognition

At this point, the computer will try to install the drivers for the PSU/Data Converter. If you are connected to the internet, they should install automatically. In the case that you are not online, the driver will not install. The prompt below may or may not appear. If you get this prompt while connected to the internet, follow the procedure below.

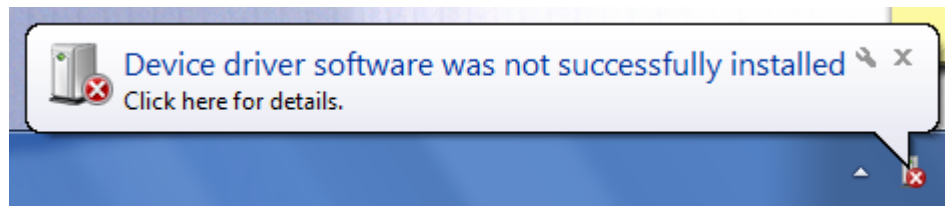

Figure 3-2: Driver Error

Go to the CD or USB drive and enter the Drivers folder.

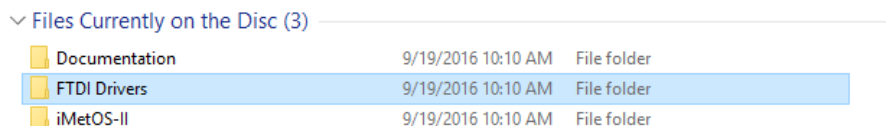

Figure 3-3: Driver Installation Folder

There will be an application in this folder. Install it and go through the process of installing it. This will install the correct drivers for the PSU/Data Converter. Once you have installed the driver, you can see the COM port number in device manager under "Ports" (Seen below).

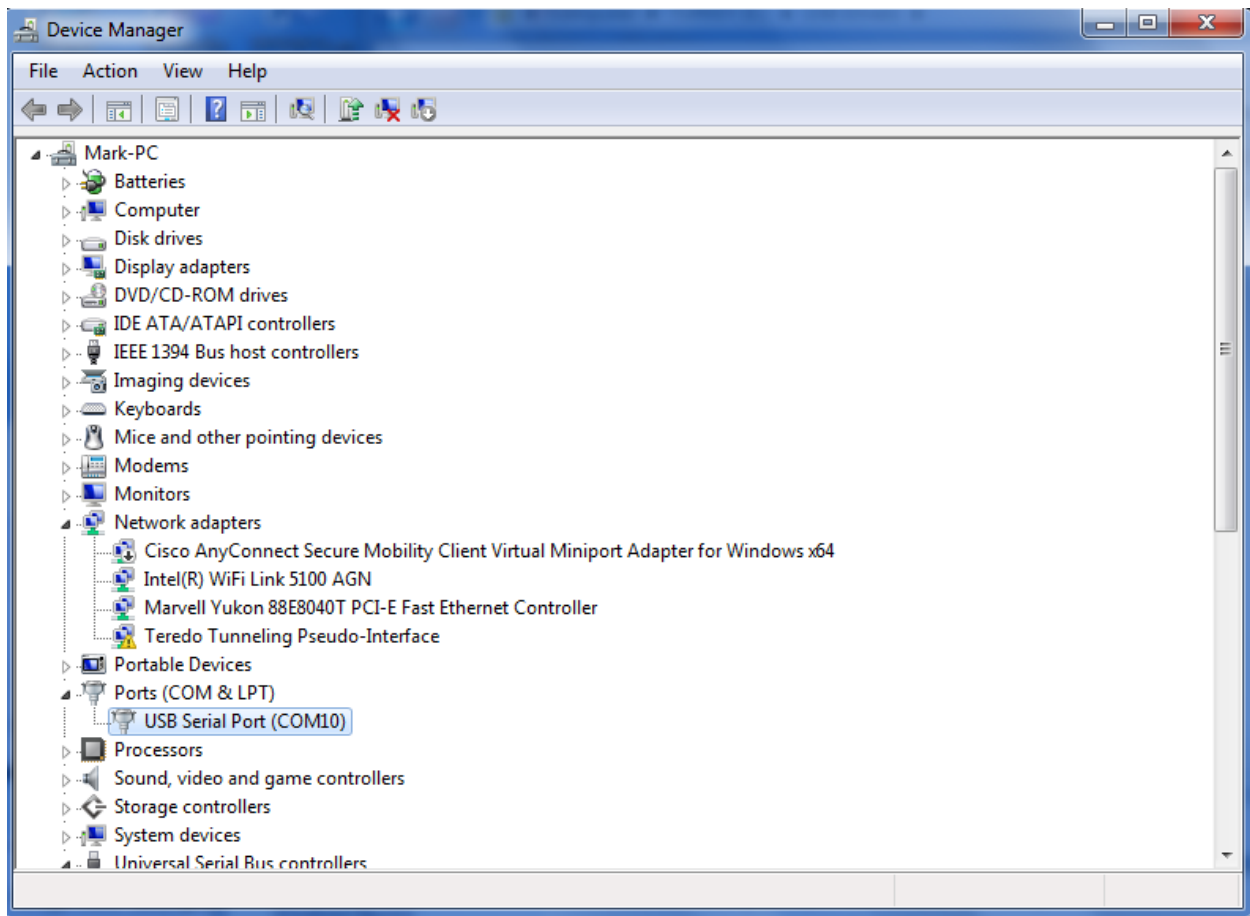

Figure 3-4: Device Manager

If the COM Port can be viewed from the Device Manager, the hardware installation is complete. This port number will be used when installing iMetOS-II.

3.3 BASIC SETUP OF IMETOS-II

3.3.1 Hardware Requirements

The software is installed on a workstation PC that is running the Windows (XP, Vista, 7, 8 or more recent) operating system.

The PC minimum requirements are:

- Pentium processor 2GHz or better
- 1Gb RAM
- 10Mb hard disk space (plus 5 to 15Mb per flight)
- 1024 x 768 screen resolution with 256 colors
- 3 USB ports (depending on peripheral equipment requirements)
- Mouse
- PDF Reader
- Internet connection (optional)
- Sound card and speakers (optional)

3.3.2 Installation

Installation is by means of a self-starting installation routine. The software will, by default, be installed into an OEM folder on the C:\ hard drive. Start the iMetOS-II application to get started.

A program group is created to contain all of the executable files relating to the package. A desktop icon may also be created for quick access to the software.

Sounding data should be stored in an accessible folder on the local hard drive. Normally this would be configured as the \Data folder off the OEM folder under Public Documents.

3.3.3 Configuring iMetOS-II

Once you have installed the software, basic presets can be made on the user interface to ensure that you configure flights according to your or the employer's preferences.

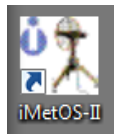

Open iMetOS-II by clicking the  icon.

3.3.3.1 Communications

To begin setup, select the "Communications" tab in the System Setup box on the home screen.

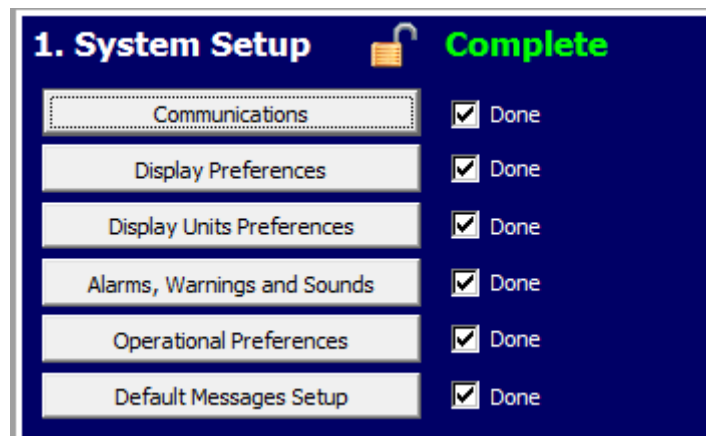

Figure 3-5: System Setup

The dialog box will list many different antennas. Select the 3050A Antenna (Seen in bold in the image). For COM port, select the open port. This will be the same port from 3.2.3.

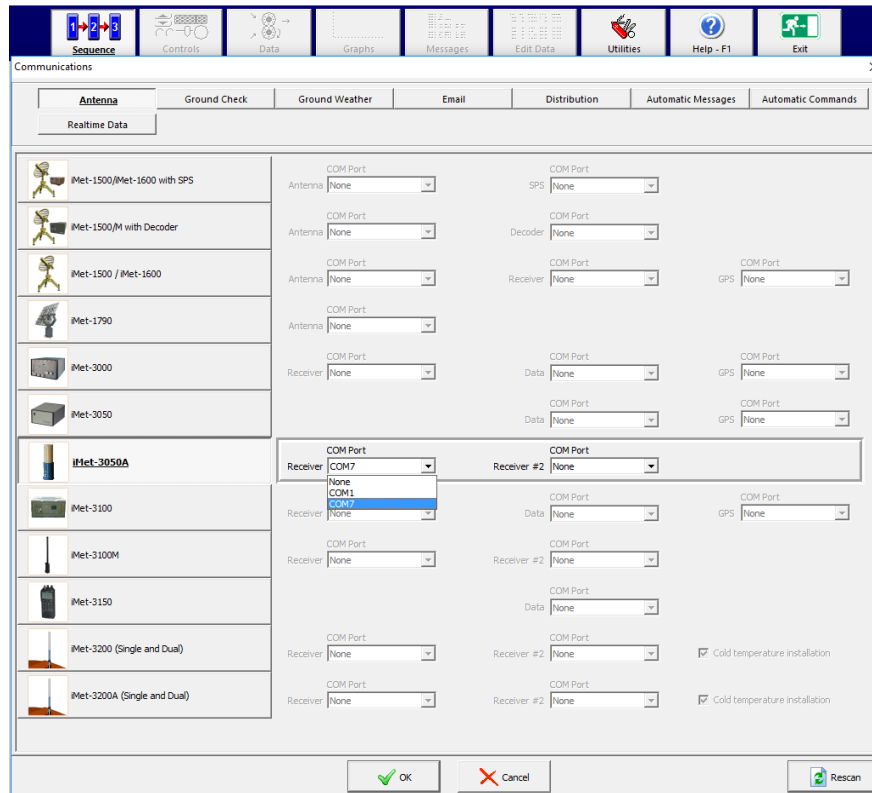

Figure 3-6

Select the "OK" button at the bottom of the prompt. For all of the other tabs at the top of the communications window, refer to International Met Systems document 200,850 iMetOS-II Software Reference Manual.

3.3.3.2 Other Tabs

The other tabs can be set-up according to your preference. Refer to InterMet Systems document 200,850 iMetOS-II Software Reference Manual for more information.

3.4 LAUNCH SEQUENCE

A successful balloon launch takes less than 30 minutes. The steps below show how to launch a radiosonde with the iMet-3050A.



3.4.1 Activate the iMet-3050A and System Computer

- a. Prepare your balloon for flight.
- b. Turn on the system computer and wait for Windows to boot.
- c. Plug in the USB Data cable to apply power to the antenna

3.4.2 Start iMetOS-II and Log in if Required

NOTE

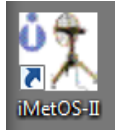
The software and hardware must already be configured in order to perform a flight. Refer to International Met Systems document 200,850 iMetOS-II Software Reference Manual for information on how to configure the software.

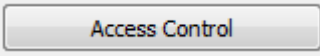
- a. Open the iMetOS-II program by double-clicking the  icon.
- b. (Optional) If required, log in as a user by selecting the  button from the main menu followed by the  menu. Click the "Log In" button as shown in Figure 3-7.

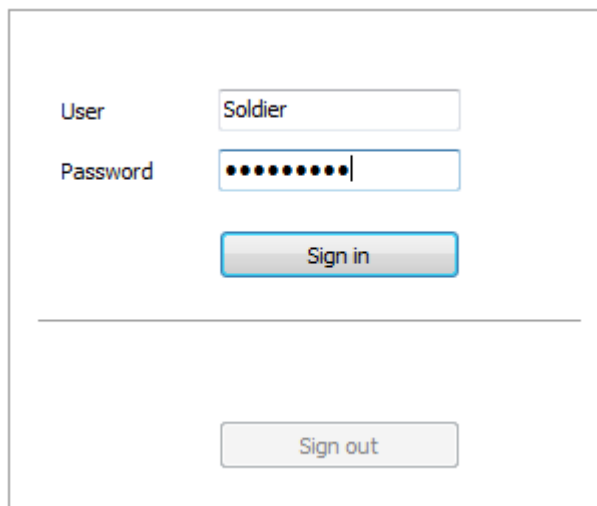



Figure 3-7 User Log In

- c. (Optional) Return to the Sequence Screen by selecting the  button.

NOTE

The default user for iMetOS-II is “administrator” with no password required.

3.4.3 Load a New Sounding

- a. Locate the "2. Sounding Setup" shown in Figure 3-8 on the Sequence Screen.



Figure 3-8: Sounding Setup

- b. Click the  button to create a new sounding name as shown in Figure 3-9

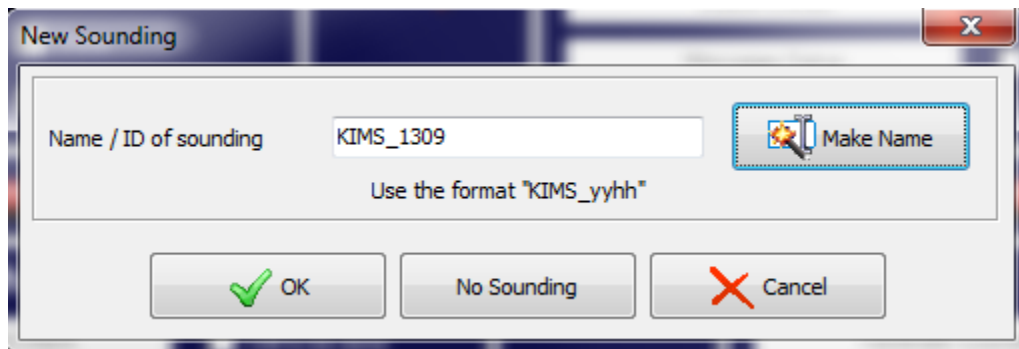

Figure 3-9: New Sounding Name

Refer to International Met Systems document 200,850 iMetOS-II Software Reference Manual for additional information on formatting the flight name.

- c. Click the  button to create a new sounding name and notice the checkbox has changed as shown in Figure 3-10.



Figure 3-10: Step Completed

3.4.4 Prepare the iMet-4 Radiosonde

- Remove the radiosonde from the shipping bag.
- Follow the instructions printed on the radiosonde cover to apply power to the radiosonde and set the desired frequency. Pay special attention to the switch position and expected frequency.

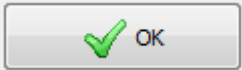
NOTE

Detailed instructions for the iMet-4, iMet-1 and iMet-2 radiosonde preparations are found in Documents 200774, 200,650 and 200,666 respectively.

3.4.5 Finishing Sounding Setup

- Click the  button and select the radiosonde as shown in Figure 3-11. Click the "OK" button when the proper radiosonde is selected.

NOTE

Proper radiosonde serial number should appear in the box when the radiosonde is activated.

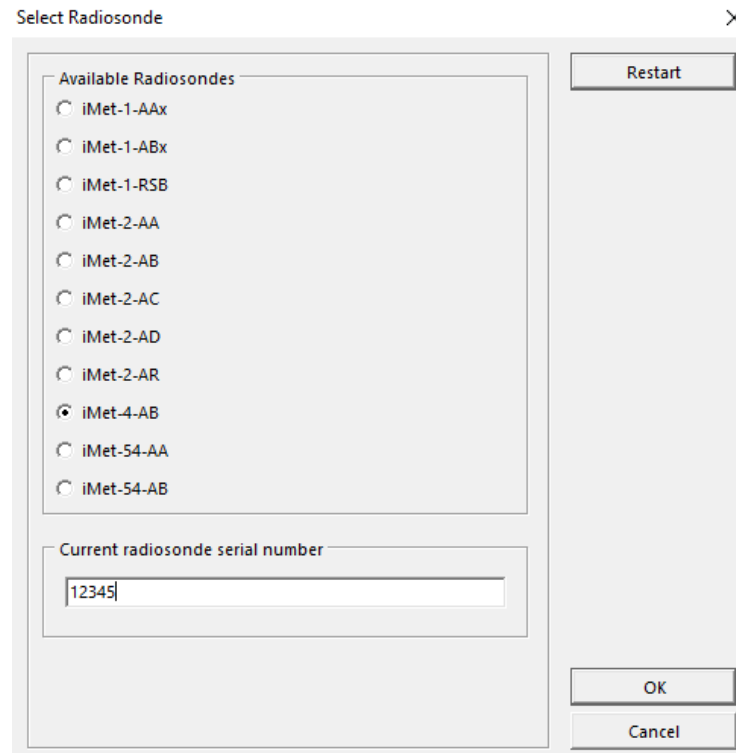



Figure 3-11: Select Radiosonde

- b. Click the  button to enter the balloon information. Click the OK button when completed.
- c. Click the  button and complete the Station Details. An example is shown in Figure 3-12.

NOTE

The "Get" and "Like Station" buttons are added to quickly enter the Station Location if a GPS solution is available from the iMet-3050A Receiver Assembly.

CAUTION

If the system is configured to work with Differential Corrections, it is extremely important that the Station Location is entered accurately. Incorrect data entry could result in high errors for wind velocities.

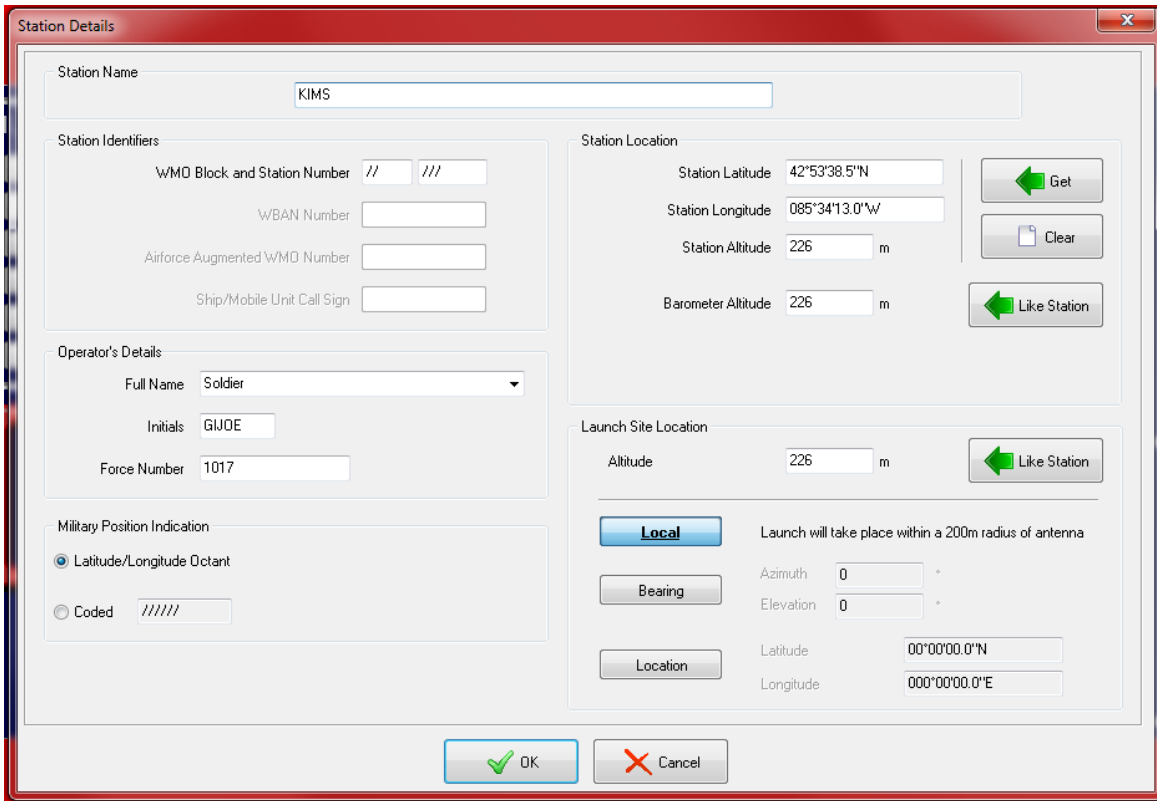
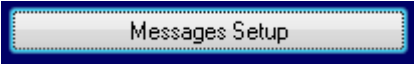



Figure 3-12: Station Details

- d. Click the  button and verify the message settings. Click the OK button when completed.
- e. Verify that radiosonde data is present at the frequency set in section 3.4.4. If data is present, it should be visible on the flight screen as shown in Figure 3-13 along with the frequency. If no radiosonde data is present, check receiver frequency by clicking the  button on the main toolbar.

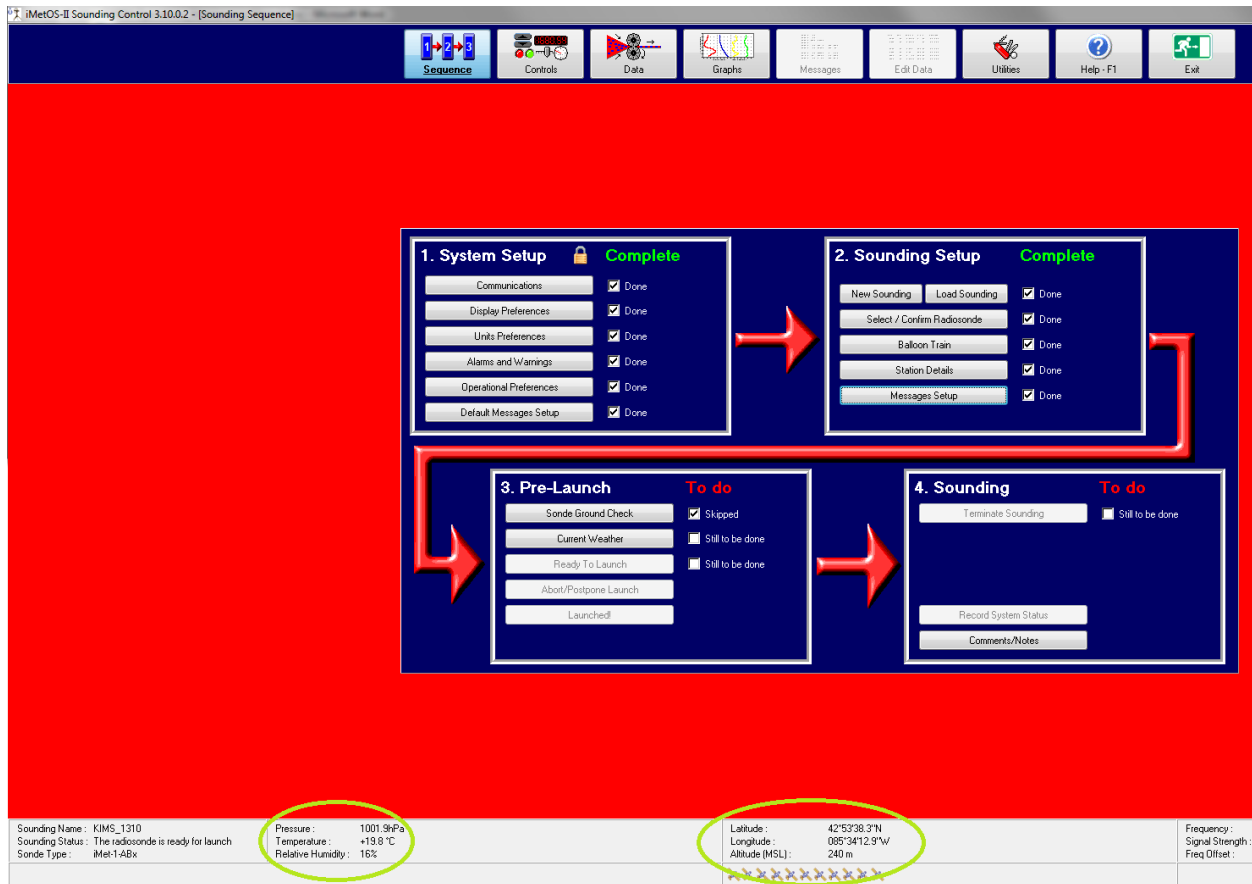

Figure 3-13: Radiosonde Data

- f. Click the  button and enter the information. An example is shown in Figure 3-14. Click the "OK" button when finished.

Figure 3-14: Current Weather

- g. Click the **Ready To Launch** button and the background of the flight screen should change from RED to GREEN. At this point, the balloon can be released at any time.

3.4.6 Inflate the Balloon and Assemble the Flight Train

- a. Inflate the balloon according the site procedure.
- b. Attach the DeReeler to the balloon as using the tie-wrap as shown in Figure 3-15.

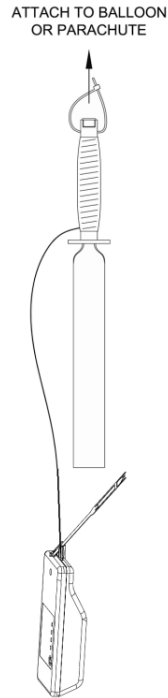

Figure 3-15: Radiosonde Flight Train

- c. Attach the radiosonde to the bottom tie-wrap as shown in Figure 3-15.

NOTE

Balloon inflation may be done before or after configuration of the radiosonde and software.

3.4.7 Release Balloon

Release the balloon.

WARNING

If the radiosonde is being launched into a controlled airspace, it is critical to notify the proper authorities to prevent collisions with air vehicles.

NOTE

iMetOS automatically detects the balloon launch and changes the flight status based upon the reported altitude change and/or pressure change. Refer to International Met Systems document 200,850 iMetOS-II Software Reference Manual to change how balloon launch is detected.

3.4.8 Flight Status Check

Once the balloon has been released, verify that the following events have occurred:

1. The checkbox next to the "Ready To Launch" button has changed from "Waiting to Launch" to "Launched."
2. The background of the flight screen has changed from GREEN to GRAY.
3. The Pre-Launch box has changed from "To Do" to "Complete."

3.4.9 Messages and Graphs

The messages and graphs can be viewed in real time by clicking the buttons on the main toolbar.

3.4.10 Flight Termination

The software will automatically detect the balloon burst. Depending on the configuration, the software may automatically terminate the flight.

This is set by the administrator in the "Operational Preferences" section of the System Setup. Instructions on how to set this feature are found in International Met Systems document 200,850 Software Reference Manual.

The flight may also be terminated at any time by clicking the "Terminate Sounding" button.

The flight termination is observed in the Sounding Box shown in Figure 3-16.

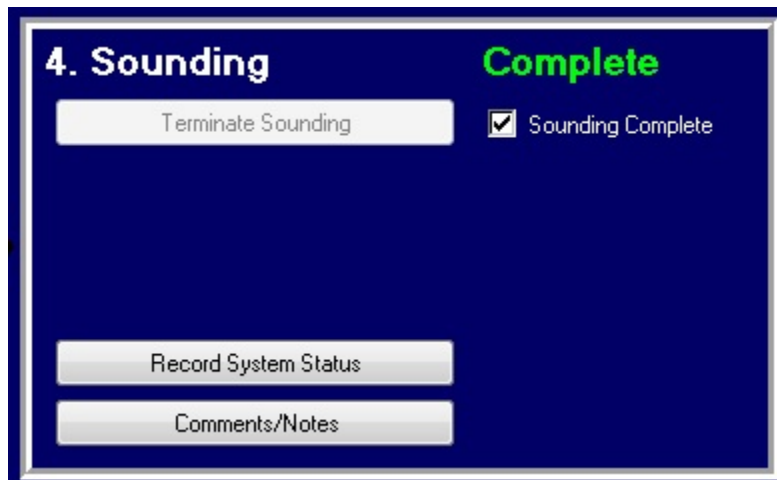

Figure 3-16: Flight Termination

3.4.11 Report Sending and Archiving

After the successful termination of the flight, the data can be sent or archived by clicking the



button on the main toolbar and followed by the

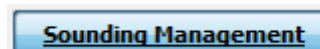

button. The

screen shown in Figure 3-17 appears and these options are all available to the user.

NOTE

The Sounding Data may also be transferred to an email address or website automatically using FTP. This is part of the System Setup in

iMetOS-II.

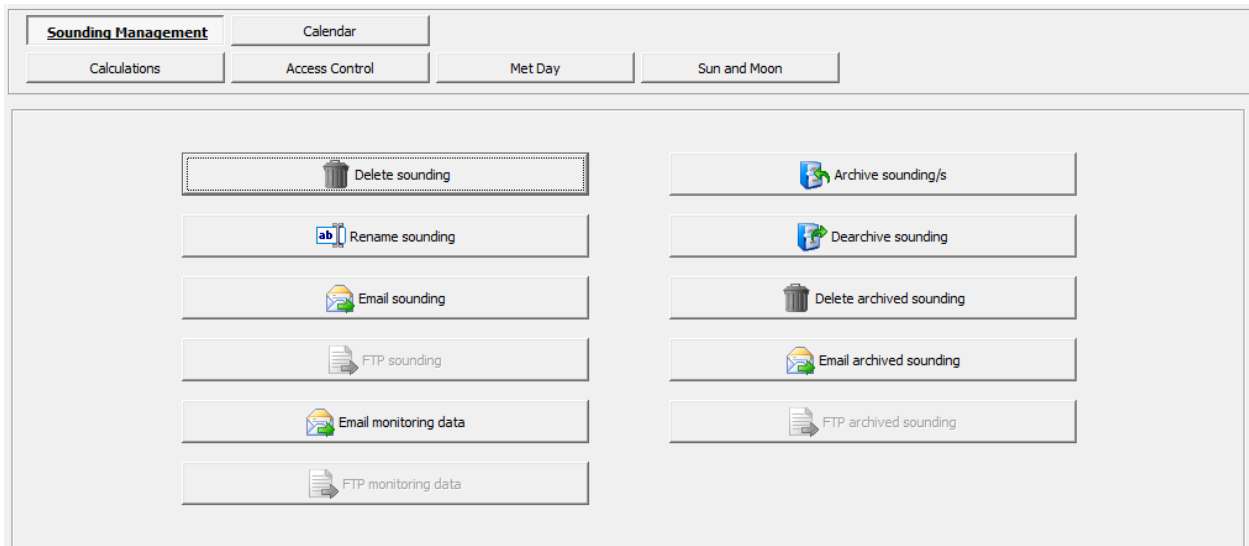

Figure 3-17: Sounding Management

CHAPTER 4 ROUTINE MAINTENANCE

4.1 GENERAL

The iMet-3050A Sounding System is a modern solid state system containing no moving parts. There is no calibration or adjustments required after installation apart from periodic checking and cleaning.

4.2 YEARLY MAINTENANCE – OUTDOOR EQUIPMENT

The following tasks should be performed every year in order to prevent premature failures of the system.

4.2.1 Antenna Connector

Check that the outdoor antenna data cable connector is not severely corroded or damaged.

4.2.2 Antenna

Proper operation of the antenna requires that it be kept clean and free from debris. Accumulations of foreign materials on the antenna will change the impedance of the unit and reduce the gain of the antenna. The antenna can be cleaned with warm soapy water. Do not clean with a high pressure water jet or immerse in water. Stubborn dirt can be removed with a mild cleaner.

4.2.3 Secure Mounting

Check that the bracket and antenna are secure and have not come loose.

4.2.4 Data Cable

Inspect all areas where the data cable is exposed for signs of damage.

4.3 INDOOR EQUIPMENT

The indoor equipment does not require any maintenance.

CHAPTER 5 LRU REMOVAL/ REPLACEMENT

5.1 GENERAL

Each iMet-3050A Sounding System LRUs can be removed and replaced as long as the power is off. The LRU replacements are not complicated and do not require any additional procedures - except for receiver assemble. This procedure is included in this chapter.

5.2 LINE REPLACEABLE UNITS

The iMet-3050A is divided into the LRUs shown in Table 5-1.

Table 5-1: iMet-3050A Line Replaceable Units

Item	Description	Stock Number
1.	Antenna/Receiver Unit	5486000100
2.	Power-Comms Cable (standard)	5486000072
3.	PSU/Data converter	5486000071
4.	USB Cable	10282
5.	Tripod	497009
6.	Transportation Case	300027

CHAPTER 6 TROUBLESHOOTING

6.1 INTRODUCTION

This section describes how to troubleshoot the system. The operator should perform the steps from **Error! Reference source not found.** FLIGHT OPERATIONS exactly as described in this manual. If the system has a malfunction, refer to the following tables for how to test the system and determine if maintenance is required.

6.2 TROUBLESHOOTING TABLES

6.2.1 Hardware

Table 6-1: Hardware Troubleshooting

Line	Symptom	Checkout Procedure(s)
1	No Receiver Communication	i) 5.3.1 Communications Checkout ii) Test cable connections using Table 6-2 iii) Perform loopback test on PSU/Data Converter iv) 6.5.1 Replace the internal parts of the antenna

Table 6-2: Cable Pinout

<u>Antenna Connector</u>	<u>Signal name</u>	<u>PSU/Data Converter (DB 9 HD - 15 pin)</u>
1	16V	4
2	16V GND	7 & 9
3	A	11
4	B	6
5	Y	1
6	Z	2

If the system meets this checkout criteria, but still does not function properly, refer back to Table 5-1.

6.2.2 Software

Table 6-3: Software Fault Isolation

Line	Symptom	Checkout Procedure(s)
1	Software "beeps" approximately once per second or no radiosonde data appears	6.3.2 Radiosonde Checkout 6.3.3 Receiver Tuning Checkout 6.3.1 Communications Checkout

Line	Symptom	Checkout Procedure(s)
2	"Make Name" does not automatically generate a new name for the sounding	Check the "Sounding Name Format" listed under the 1.System Setup-->Operational Preferences
3	Radiosonde GPS does not appear in the main flight screen	Cycle power to the radiosonde and move it outdoors in clear view of GPS
4	2.Sounding Setup-->Station Details, the "Get" button does not automatically enter the station GPS Information	Move the 403 MHz antenna outdoors and in clear view of GPS. Perform 6.3.1 Communications Checkout
5	3.Sounding Setup-->Sonde Ground Check reports "The ground check unit is not configure or offline"	Do not click this button. This should already have a checkbox with "Skipped" and this function does not apply to this system.
6	3.Sounding Setup-->Current Weather "Get" button does not automatically enter the ground station data or is disabled	1. System Setup-->Communications "Ground Weather" is configured properly.

6.3 CHECKOUT PROCEDURES

6.3.1 Communications Checkout

Table 6-4: Communications Checkout

Check	Test
1	Power is applied to the System
2	All system cables are connected
3	1.System Setup-->Communications is set to "iMet-3050A" with a COM port that exists on the computer
4	The COM port shown in Check 3 is visible in Windows Device Manager
5	2. Sounding Setup-->Select/Confirm Radiosonde is set to the proper radiosonde type

6.3.2 Radiosonde Checkout

Table 6-5: Radiosonde Checkout

Check	Test
1	The battery connector inside of the radiosonde is plugged in.
2	The frequency switch is on one of the four frequencies – not in the first position.
3	The internal LED of the radiosonde is blinking.
4	Replace the radiosonde battery and perform checks 1 – 3.

If the radiosonde does not satisfy the following tests, replace the radiosonde.

6.3.3 Receiver Tuning Checkout

If the radiosonde data does not appear to be the screen, but the radiosonde is turned on and the LEDs are functioning according to Section 6.3.2, perform the following checks:

Table 6-6: Receiver Tuning Checkout

Check	Test
1	2.Sounding Setup-->Select/Confirm Radiosonde is set to the proper radiosonde type
2	The radiosonde is on and transmitting (see Table 6-5)
3	Click the "Controls" button and verify that "Communications : All Online" and "Equipment Status : All Systems OK" is visible. If not, perform 6.3.1 Communications Checkout
4	From the "Controls" menu, verify that the signal strength is above -90 dBm and AFC is ON.

CHAPTER 7

CONTACTING SUPPORT

7.1 IDENTIFYING PROBLEMS

InterMet Systems prides itself in making itself available to the customers' needs before, during, and after the installation of equipment. InterMet Support may be contacted by email, phone or fax.

7.2 MEANS OF CONTACT

Email: support@intermetsystems.com

Phone: +1 (616) 971-1005 – Ask for Customer Support

7.3 SENDING DATA

When contacting support, it is advisable to give us a thorough explanation of the problem and what steps were being taken prior to the problem arising.

E-mail provides the best means to contact support, as log files and data can be sent electronically to InterMet Systems. When a problem occurs, please use the e-mailing facility that is built into the iMetOS-II software to send the data of the sounding (or attempted sounding) to InterMet Systems.

To send e-mails from within the iMetOS-II software requires that the SMTP server and other information first be configured. This is done under the “Sequence → Communications Setup” screen, and is normally done only once, during system installation.

The Utilities / Sounding Management /E-Mail sounding function is used to send the data from a selected sounding to InterMet Systems. If the sounding has already been archived, the Utilities / Sounding Management /E-Mail archived sounding function should be used.

Users should make use of the Comments facility for appending notes to a particular sounding. This feature is found on the Sequence screen, in the Sounding section.