



Data Synopsis for **HLY0701** **BEST**



April 10 – May 12, 2007

Dutch Harbor to Dutch Harbor

Chief Scientist- Raymond Sambrotto

Healy Captain- Captain Tedrick R. Lindstrom



Prepared by: Tom Bolmer, David Forcucci, David Hassilev, & Steve Roberts

Table of Contents

<i>Project Summary</i>	5
<i>Cruise Track</i>	6
<i>Personnel</i>	7
Science Party Personnel	7
Ship's Crew	10
a. Officers	10
b. Enlisted Personnel	10
c. Enlisted Personnel TAD	11
<i>Science Components and their major sampling activities</i>	12
<i>Distribution Contents</i>	13
Introduction to Data	13
Data	14
Distribution DVD Contents at a Glance	14
Directories on the first DVD:	15
I_Minute_Averaged_Data:	15
Datalog:	15
Meta_data:	17
Raw:	17
First DVD Contents by directory:	17
Directories on the second and subsequent DVDs:	19
Raw:	19
Images:	19
Second DVD Contents by directory:	20
<i>Merged Data</i>	21
SCS One Minute Data File	21
LDEO Averaged One Minute Data File	23
<i>Underway Sensors</i>	26
Meteorology & Radiometers	26
Underway Ocean	26
Sonars	26
Navigation	26
<i>File Formats of Data Collected on HLY0701</i>	27
<i>./Datalog</i>	27
Under way Data	27
Meteorology Data	27
R. M. Young Sensors	27
R.M. Young Air Temperatures	27
R.M. Young Air Temperatures, Fahrenheit (Derived)	28
R.M. Young Wind, Port	28
R.M. Young Wind, Starboard	29
R.M. Young Wind True, Port (Derived)	30
R.M. Young Wind True, Starboard (Derived)	31
Dew Point (Derived)	31
Photosynthetic Active Radiation (PAR) Sensor	32
PAR	32
PAR (Derived)	32

HLY0701 Data Synopsis

Oceanographic Data	33
Thermosalinograph / Fluorometer	33
AFT Theromsalinograph / Fluorometer	33
Forward Theromsalinograph Flowmeter	33
Forward Thermosalinograph / Fluorometer	34
Before 4/13/07 05:26	34
After 4/13/07 05:26	35
Sonar Data	36
Seabeam 2112 Center Beam	36
Knudsen	37
3.5 kHz	37
Winch data	38
Starboard A-Frame Winch Data	38
Aft A-Frame Winch Data	38
Navigation Data	39
POSMV	39
POSMV GGA	39
POSMV Psuedo Noise	40
POSMV HDT	41
POSMV PASHR	42
POSMV VTG	43
POSMV ZDA	44
Ashtech GPS	45
Ashtech Attitude	45
Ashtech GGA	46
Ashtech GGL	47
Ashtech HDT	48
PCode	49
PCode AFT	49
PCode Aft GGA	49
PCode Aft GLL	50
PCode AFT VTG	51
PCode AFT ZDA	52
PCode Bridge	53
PCode Bridge GGA	53
PCode Bridge GLL	54
PCode Bridge VTG	55
Glonass	56
Glonass GGA	56
Glassnos GLL	57
Gyro	58
Gyro Heading	58
Waypoints	59
IBS Waypoints	59
Speed Log	60
Sperry Sped Log	60
Sound Velocimeter	60
SV2000	60
./Raw	61
75 KHz ADCP data	61
150 Khz ADCP data	61
KNUDSEN 320B/R	62
POSMV	62
POSMV Events	62
Seabeam	62
Thermosalinograph	63
Thermosalinograph AFT	63
Thermosalinograph Forward	63
CTD	63
Expandable Bathythermograph (XBT)	64
Oxygen Concentration Sensor	64

./Images	64
Aloft Con Camera	64
Fan Tail Camera	65
Satellite Images	66
/hrpt	66
/dmsp	66
APPENDIX:	67
Acquisition Problems and Events	67
Calculations	72
TSG	72
Before 04/13/07	72
After 04/13/07	72
PAR	73
Sensors and Calibrations	74
HLY0701 Shipboard Sensors	74
HLY0701- CTD Sensors	75
Calibrations	76
Turner SCUFA Fluorometer	76
Seabird SBE21 Thermosalinograph Calibration	78
Serial number 1864 Conductivity Calibration	78
Serial number 1864 Temperature Calibration	79
MET Sensors	80
PAR	80
R.M. Young Wind Bird, Starboard	81
R.M. Young Wind Bird Port	82
CTD Sensors	83
Pump	83
Serial number 53115	83
Temperature	85
Serial number 2824	85
Serial number 2841	86
Conductivity	87
Serial number 2545	87
Serial number 2619	88
Oxygen	89
Serial number 0458	89
Transmisometer	90
Serial number CST-390DR	90
PAR Sensor	91
Serial number 70115	91
Pressure Sensor	92
Serial number PO638	92
Fluorometer	93
Serial number 088234	93
Instrument Locations on the Healy	94
Layout plot of instrument locations	94
Table of Survey measurements	95
Healy EK50 Installation and Trigger Block Diagram	98
HLY0701 Media Index	99
Example list of the DVD directories	100
First DVD	100
Second DVD	101
SBE 21 SEACAT Thermosalinograph Data Output Formats	103

Project Summary

Bering Sea Ice Expedition Research Activities

INTRODUCTION

Although the Bering Sea is far from where most people live, it is a very important place:

- * Climatically – Water from the Pacific Ocean flows through the Bering Sea on its way to the Arctic Ocean or to recirculate southward into the Pacific again. Changing sea-ice conditions, temperature and salinity in the Bering Sea can influence conditions in the Arctic Ocean. Changes in the Bering and the Arctic may have a profound effect on global climate.

- * Economically – About half of the United States harvest of fish and shellfish comes from Alaskan waters, and most of that from the Bering Sea.

- * Ecologically – The Bering Sea is home to a very rich, diverse ecosystem. Some of the animals of the Bering Sea are endangered (i.e. Steller's sea lion, bowhead and northern right whales) and many more are being forced to adjust to changing conditions.

- * Culturally, The Bering Sea and its resources are important to the cultural identity and way of life of many Native Alaskan communities that live on its margins.

As a marginal ice zone, the Bering Sea is influenced strongly by sea ice:

- * Sea ice determines the temperature, salinity and stratification of the water in the northern Bering Sea.

- * Timing and location of sea ice may determine the timing and strength of the spring phytoplankton bloom. Because phytoplankton form the base of the food web, changes in the spring bloom can influence the entire ecosystem.

- * The ice edge is a unique habitat required by walrus and four species of seals to haul out, molt and bear their young.

- * The sea ice-edge environment is probably of great importance to the ecosystem, as it may concentrate prey for fish, birds and mammals.

Sea-ice extent has been decreasing in the Bering Sea. If sea ice disappears from this region, what will happen to the unique ice-edge ecosystem? Observations made on this expedition will help us to understand links between sea water, sea ice and the plants and animals that make up this ecosystem. This information will help us to understand the potential impacts of climate change on the Bering Sea ecosystem. We can then apply this understanding to more effective management of the vast and varied marine resources of this region.

Cruise Track

HLY0701 04/12/07 - 05/12/07

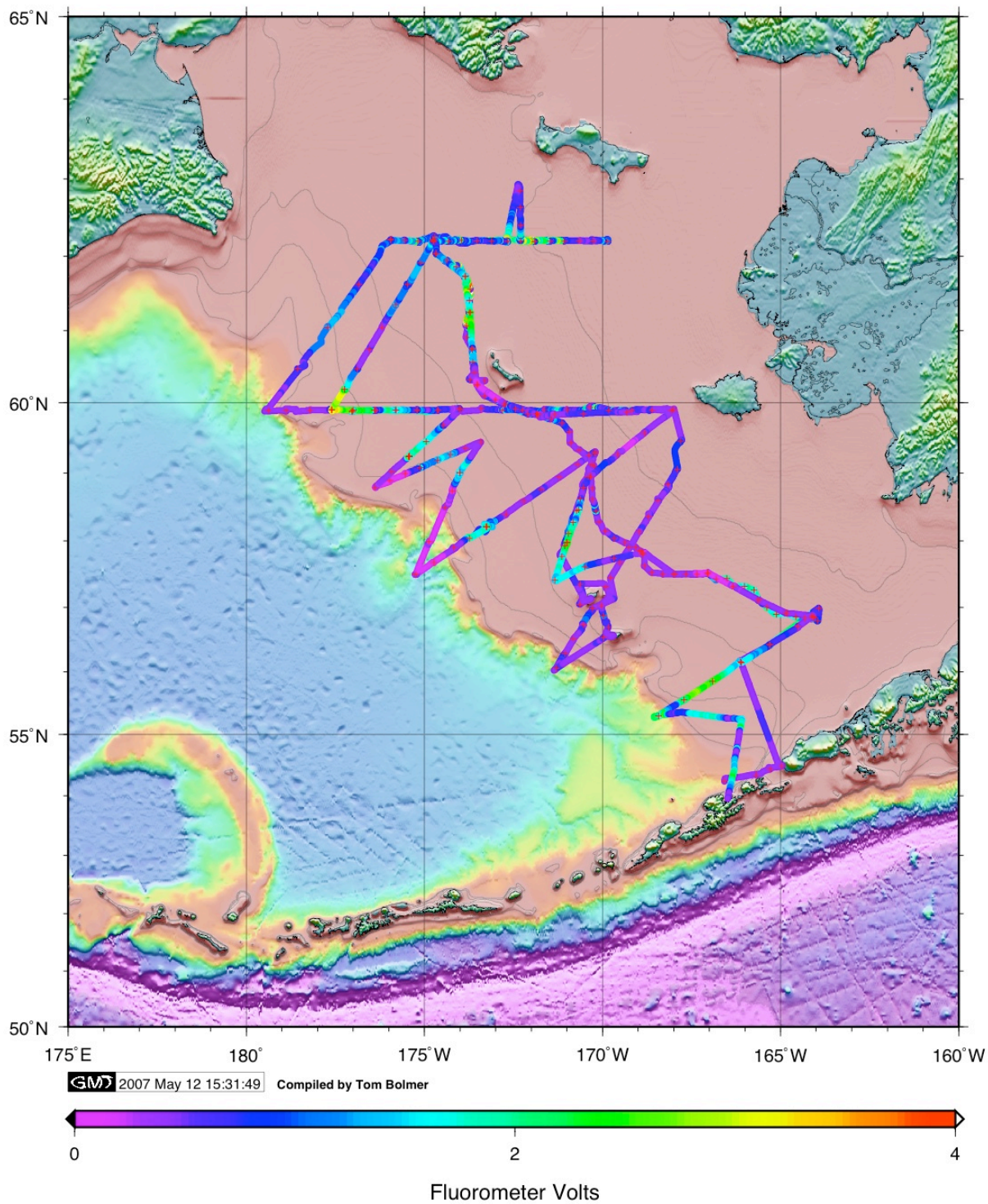

Personnel**Science Party Personnel**

Name	Institution	Phone	Email	Date On	Date Off
Raymond Sambrotto	Lamont-Doherty	845-365-8402	sambrott@ldeo.columbia.edu	4/10/07	5/12/07
David Shull	Western Washington University	360-650-3690	david.shull@wwu.edu	4/10/07	5/12/07
Emily Davenport	Western Washington University	360-491-5153	tropicalfishy4@hotmail.com	4/10/07	5/12/07
Allan Devol	University of Washington	206-543-1292	devol@u.washington.edu	4/10/07	5/12/07
Bonnie Chang	University of Washington		bchang@ocean.washington.edu	4/10/07	5/12/07
Kris Swenson	Lamont-Doherty	845-365-8780	kswenson@ldeo.columbia.edu	4/10/07	5/12/07
Didier Burdloff	Lamont-Doherty	845-365-8619	burdloff@ldeo.columbia.edu	4/10/07	5/12/07
Julie Granger	Princeton		granger@eos.ubc.ca	4/10/07	5/12/07
Maria (Masha) Prokopenko	Princeton	323-630-4968	mprokope@princeton.edu	4/10/07	5/12/07
Rob Rember	University of Alaska Fairbanks	907-474-2795	rremember@iarc.uaf.edu	4/10/07	5/12/07
Ana M Aguilar-Islas	University of Alaska Fairbanks	831-459-2682	aaguilar@iarc.uaf.edu	4/10/07	5/12/07
Phyllis Stabeno	NOAA/PMEL	206-526-6453	Phyllis.Stabeno@noaa.gov	4/28/07	5/12/07
Dylan Righi	JISAO/Univ. of Wash	206-526-6508	Dylan.Righi@noaa.gov	4/10/07	4/27/07
Calvin Mordy	JISAO/Univ. of Wash	206-526-6870	calvin.w.mordy@noaa.gov	4/10/07	5/12/07
Nancy Kachel	JISAO/Univ. of Wash	206-526-6746	nancy.kachel@noaa.gov	4/10/07	5/12/07
David Kachel	NOAA/	206-526-	dave.kachel@noaa.gov	4/10/07	5/12/07

HLY0701 Data Synopsis

Name	Institution	Phone	Email	Date On	Date Off
	PMEL	6195			
Carol Ladd	NOAA/ PMEL	206-526-6024	carol.ladd@noaa.gov	4/28/07	5/12/07
Edward Cokelet	NOAA/ PMEL	206-526-6820	edward.d.cokelet@noaa.gov	4/10/07	4/27/07
Jeff Napp	NOAA/ AFSC	206-526-4148	jeff.napp@noaa.gov	4/10/07	4/27/07
Robert Freyer	NOAA/ AFSC			4/10/07	4/27/07
Brianna Blaud	NOAA/ AFSC			4/10/07	4/27/07
A.J. LeFevre	NOAA/ AFSC			4/10/07	4/27/07
Jay Clark	NOAA/ AFSC			4/28/07	5/12/07
Ingrid Spies	NOAA/ AFSC			4/28/07	5/12/07
Rachael Cartwright	NOAA/ AFSC			4/28/07	5/12/07
Kathy Mier	NOAA/ AFSC			4/28/07	5/12/07
Michael Cameron	NOAA/ NMML	206-526-6396	Michael.Cameron@noaa.gov	4/10/07	5/12/07
Dave Withrow	NOAA/ NMML	206-526-4019	dave.withrow@noaa.gov	4/10/07	5/12/07
Gavin Brady	NOAA/ NMML	206-526-4035	gain.brady@noaa.gov	4/10/07	5/12/07
Shawn Dahle	NOAA/ NMML	206-526-4035	shawn.dahle@noaa.gov	4/10/07	5/12/07
Josh London	NOAA/ NMML	206-526-4296	josh.london@noaa.gov	4/10/07	4/27/07
Jay VerHoef	NOAA/ NMML	907-456-4321	jay.verhoef@noaa.gov	4/28/07	5/12/07
Lee Harris	NOAA/ NMML			4/10/07	5/12/07
Carleton Ray	University of Virginia	434-924-0551	cr@virginia.edu	4/1/07	5/12/07
M. Geraldine McCormick-Ray	University of Virginia			4/1/07	5/12/07
David Hyrenbach	University of Washington	206-221-4494	khyrenba@u.washington.edu	4/10/07	5/12/07

HLY0701 Data Synopsis

Name	Institution	Phone	Email	Date On	Date Off
Kathy Kuletz	US F&WS	907-786-3453	kathy_kuletz@fws.gov	4/10/07	4/27/07
Liz Labunski	US F&WS	907-786-3865	elizabeth_labunski@fws.gov	4/10/07	5/12/07
Alex De Roberis	NOAA/ AFSC	206-526-4789	Alex.DeRobertis@noaa.gov	4/10/07	5/12/07
Scott Hiller	Scripps	858-534-1907	scott@odf.ucsd.edu	4/10/07	6/19/07
Parisa Nahavandi	Scripps	858-534-1903	parisa@odf.ucsd.edu	4/10/07	5/12/07
Chris Holm	Oregon State Univ.	541-737-9369	cholm@coas.oregonstate.edu	4/10/07	5/12/07
Steve Roberts	UCAR	303-497-2637	sroberts@ucar.edu	4/3/07	6/17/07
Tom Bolmer	WHOI	508-289-2628	tbolmer@whoi.edu	4/3/07	6/17/07
Janet Scannell	NCAR/EOL	303-497-1093	anstett@ucar.edu	4/3/07	5/12/07
Bill Springer	Maritime helicopters	907-235-7771	info@maritimehelicopters.com	4/10/07	5/12/07
Charles Sims	Maritime helicopters			4/10/07	5/12/07
David Doucet	OAS/ BLM	907-267-1360	ddoucet@ak.blm.gov	4/10/07	5/12/07
Robyn Staup	Boonshoft Museum of Discovery	937-275-7431 x154	rstaup@boonshoftmuseum.org	4/10/07	5/12/07
Maggie Prevenas	Kalama Intermediate School	808-573-8753	prevenas@wisprus.com	4/10/07	5/12/07
David Hassilev	Network Technican		David.M.Hassilev@uscg.mil	4/10/07	5/12/07
David Forcucci	USCG Science Liaison		David.Forcucci@uscg.mil	4/10/07	4/28/07
Clive Reed	Converteam training and tech support			4/10/07	5/12/07

Ship's Crew

HEALY Sailing List for 10 April 2007.

a. Officers

CAPT TEDRIC R. LINDSTROM
 CDR JEFFREY C. JACKSON
 LCDR JAMES W. DALITSCH
 LCDR MARK F. HAMMOND
 LCDR LAURA E. KING
 LTJG ERIN M. CALDWELL
 LTJG MICHAEL A. CARR
 LTJG STEPHEN M. ELLIOTT
 LTJG ELIZABETH J. NEWTON
 LTJG NATHANIEL P. SELAVKA
 ENS JOSH L. SMITH
 ENS CYNTHIA S. TRAVERS
 CWO3 JOHN W. WARD

b. Enlisted Personnel

ETCM PETER J. PERRON
 BMCS TIMOTHY R. SULLIVAN
 FSCS ANTHONY WILLIAMS
 MKCS GREG E. JONES
 BMC WAYNE L. KIDD
 DCC GEORGE W. MARSDEN
 ETC AARON P. DAHLEN
 MKC JOHN C. BROGAN
 MSTC MARK E. RIEG
 OSC SORJEN T. MANANGAN
 YNC JAMES C. ANGELO
 DC1 JAMES R. PENTECOST
 EM1 DANIELL E. HURTADO
 EM1 HANS D. SHAFFER
 EM1 KENNETH W. WORRELL
 ET1 BRIAN A. LIEBRECHT
 FS1 ARRENE N. ZITTING
 IT1 DANIEL A. VON KAUFFMANN

MK1 KEVIN A. GASKINS
 MK1 ROBERT B. QUICHOCHO
 MK1 DIANE R. WALLINGFORD
 MST1 CHARLES M. BARTLETT
 MST1 ROB A. OLMSTEAD
 MST1 ERIC P. ROCKLAGE
 SK1 JACQUES P. FAUR
 SK1 TERENCE J. MCNALLY
 BM2 BRANDON D. ALANI
 BM2 ASHLEY W. DAVIDSON
 EM2 KELVIN D. HERNANDEZ
 ET2 SAUL N. KOSYDAR
 ET2 MATTHEW R. REGELE
 FS2 JOHN B. CARTER II
 FS2 LINZI S. DEGGANS
 FS2 TAMEKIA K. WRIGHT
 MK2 RICHARD D. ERICKSON
 MK2 JON F. LOFTIS
 MK2 ROBERT J. MYERS
 MK2 ALLAN E. WHITING
 MST2 CHAD W. KLINESTEKER
 MST2 RICHARD L. LAYMAN
 MST2 TIFFANY S. WRIGHT
 SK2 REBECCA K. ARAKAKI
 BM3 AIMEE E. BUFORD
 BM3 WILLIAM J. CONROY III
 BM3 LARA E. DUNNING
 BM3 ANDREW S. YECKLEY
 DC3 MONTARNO A. MANDRIE
 EM3 NATHAN A. FINLEY
 ET3 STEVEN W. DAEM
 FS3 STEVEN D. DULL
 FS3 HERBERT M. HAMILTON
 MK3 FERNANDO GONZALEZ

MK3 COREY N. SMITH

FN PAUL A. BLAS

FN GLENDA M. HYMES

FN ALEXANDER WAGNER

FN MARQUESSA M. WILLIAMS

SN CHELSEY R. FERNANDEZ

SN SCOTT A. HAFNER

SN JAMES T. MERTEN, JR.

SN JONATHAN C. REED

SN JENNAE L. THOMPSON

c. Enlisted Personnel TAD

HSC JOHN S. HERRERA

EM1 BRAD R. JOPLING

EM2 ANDREW R. PADILLA

EM2 CHRISTOPHER M. WILSON

SA KAMUELA K. NAHINU

Science Components and their major sampling activities

Component, PIs	Sampling activities
1) Hydrography and circulation - Phyllis Stabeno; NOAA PMEL	CDT cast; drifter releases
2) Nutrient and oxygen fields – Cal Mordy; NOAA PMEL.	Water sampling with Niskin bottles.
3) Nitrogen productivity and isotopic budget – Ray Sambrotto; LDEO & Dan Sigman; Princeton incubations, ice sampling	Water sampling with Niskin bottles,
4) Iron distribution - Jingfeng Wu; UAF	Water sampling with trace metal clean bottles, ice sampling
5) Productivity, sediment fluxes and benthos - Al Devol; UW & David Shull; WWU	Water sampling with Niskin bottles, multicorer deployments
6) Zooplankton & meroplankton – Jeff Napp; NOAA PMEL	Plankton net hauls
7) Ice Seal Project – P. Boveng, M. Cameron, NOAA	Bearded, spotted, ringed, and ribbon seals - aerial shipboard surveys; satellite tagging
8) Bird observations – Kathy Kuletz; Fish and Wildlife Service; K. David Hyrenback, UW	Observations from ship & ice
9) Walrus observations; Carleton Ray; UVA	Observations from ship, helicopter and ice
10) Echo location and estimation of fish and krill – Chris Wilson & Alex De Robertis; NOAA	simrad EK60 scientific echosounders
11) CTD support and data management – Scott Hiller, Parisa Nahavandi, Scripps; Janet Scannell, NCAR/EOL	CTD/ Niskin sampling.
12) Underway bottom profile measurements and science support - Steve Roberts, UCAR; Tom Bolmer, WHOI.	Active acoustic system
13) Helicopter support – Maritime Helicopters	Surveys of ice field, transport of scientists & gear. teachers at sea.
14) Education & outreach – Robyn Staup, Boonshoft Museum; Maggie Prevenas, Kalama Intermediate School	Blog from the ship; follow up curriculum development.

Distribution Contents

Introduction to Data

The Healy data acquisition systems continuously log data from the instruments used during the cruise. This document describes:

- The structure and organization of the data on the distribution media.
- The format and contents of the data strings.
- Formulas for calculating values.
- Information about the specific instruments in use during the cruise.
- A log of acquisition problems and events during the cruise that may affect the data.
- Scanned calibration sheets for the instruments in use during the cruise.

The data is distributed on a series of DVD-ROMs (DVD-R) written in ISO9660 level-4 format. It is readable by virtually every computing platform.

IMPORTANT: Read the section, “Acquisition Problems and Events,” for important information that may affect the processing of this data.

There are two logging systems on the Healy. The ship (ESU) runs the SCS logging system and the LDEO support group runs the LDS logging system. This provides some redundancy in logging. The main purpose of LDS is to support the sonars and its output is saved in Raw/pos_mv.

The Scientific Computer System (SCS) is a data acquisition, and display system designed for Oceanographic, Atmospheric, and Fisheries research applications. It acquires sensor data from shipboard oceanographic, atmospheric, and fisheries sensors and provides this information to scientists in real time via text and graphic displays, while simultaneously logging the data to disk for later analysis. SCS also performs quality checks by monitoring I/O, providing delta/range checks and plotting data after acquisition.

The LDEO Data System is somewhat distant relative of the logging code that has grown through more than a decade of use at LDEO. It is a significant revision of the current (2004) code used on the R/V Ewing (the Ewing Data System) and is architecturally much different. Because of this, LDS is still growing and at the moment (2005) this is the only operational implementation.

Data

Data are received via RS-232 serial connections. In SCS a time tag is added at the beginning of each line of data in the form,

mm/dd/yyyy, hh:mm:ss.sss,[data stream from instrument] where:

Format	Value used
mm	2 digit month of the year
dd	2 digit ay of the year
yyyy	4 digit year
hh	2 digit hour of the day
mm	2 digit minute
ss.sss	seconds

An example string from the Seabeam Centerbeam file is:

04/13/2007,06:49:20.920,\$SBCTR,2007,4,13,06:49:09.437,57.158792,-165.664322 ,69.15,60*00

All times are reported in UTC.

The delimiters that separate fields in the raw data files are commas. Care should be taken when reprocessing the data that the field's separations are clearly understood.

Distribution DVD Contents at a Glance

Most data files are gzipped before they are written to the DVD to save space on the DVD.

There are two types/styles of DVDs created for the data for the cruise

The first DVD in the data set contains a summary of all of the data, descriptions and smaller data sets. It has a 1 minute averaged file of all the data collected under way. It also has ASCII files of many of the sensors from which data are collected. These sensors are ones that do not create huge amounts of data. There is also a directory called Meta_Data, which has descriptions of the data and the formats used. This DVD is created at the end of the cruise.

The second and subsequent DVDs contain data from sensors that create large amounts of data. These DVDs are created during the cruise as the data collected covers enough disk space to fill a DVD. By making these DVDs during the cruise, the time to create the full data set at the end of the cruise is shortened. Some data sets in this category cover several DVDs. Are must be taken to be sure all of the data of a certain type are recovered when you down load data form these DVDs to your own computers.

Appendix "Example list of the DVD directories" below for an example of the layout of each of the DVDs created.

The DVD will be name for the cruise and the number of the DVD in the series created for the cruise. So, the second DVD for HLY0701 will be named **HLY0701Vol2**. The root directory on the DVD will be **media-vol2**. This naming convention will let your copy all of the DVDs to a directory and keep each DVD unique but in a named sequence for accessing.

In the main directory is a file that lists all of the files on the DVD. This file is called:

media-volxx.md5: This file is a master list of every file on the DVD the file's checksum. The x is the DVD volume number.

Directories on the first DVD:

1_Minute_Averaged_Data: This directory contains all of the under way data averaged over a 1 minute window in time.

Datalog: This directory contains serial data collected by the SCS version 3.3b data collection system in different directories. Directory names are labeled by the instrument name and string type of the data collected. A description of the data contained in this directory is below.

Raw: This directory contains raw data as recorded by individual instruments and put into different directories. Directory names are labeled by the instrument name and string type of the data collected. A description of the data contained in this directory is below.

Meta_data: This directory contains documents useful in the post analysis of the data on this DVD media set. The data type are separated into different directories by type. A description of these directories is below.

1_Minute_Averaged_Data:

hly0701_distance.csv.gz - Distance along track from port.

HLY0701_Averaged.csv.gz - All the Under way data averaged for 1 minute.

Shapefile - All of the 1 minute under way data averaged at 1 minute spacing in an ESRI GIS Shapefile.

Datalog:

/aft_a_frame - Wire tension, wire out, and wire speed for the Aft A frame sheaves.

/air_temp_f - Temperature data from the RM Young wind sensor in Fahrenheit. Data is derived from data from files in the rmyoung_air directory

/ashtech_attitude - Attitude in NMEA format from the Ashtech ADU5 GPS receiver

/ashtech_gga - Position data in NMEA GGA format from the Ashtech ADU5 GPS receiver

/ashtech_gll - Position data in NMEA GLL format from the Ashtech ADU5 GPS receiver

/ashtech_hdt - Heading data in NMEA HDT format from the Ashtech ADU5 GPS receiver

/dew_point_f - Dew point temperature derived from air temp

/glonass_gga - Position data in NMEA GGA format from the GLONASS GPS receiver.

/glonass_gll - Position data in NMEA GLL format from the GLONASS GPS receiver.

/gyro - Heading data in NMEA HDT format from the Sperry gyrocompass

/ibs_waypoints - Waypoints from the Healy's Integrated Bridge System

HLY0701 Data Synopsis

/knudsen - Depth data in a proprietary PKEL format received from Knudsen 320 B/R serial output

/par- Photosynthetic Active Radiation volts from the surface par sensor

/par_derived - Photosynthetic Active Radiation, Microeinstens/m2 sec from surface par sensor

/pcode_aft_gga - Position data in NMEA GGA format from the Trimble Centurion receiver located in the Computer lab

/pcode_aft_gll - Position data in NMEA GLL format from the Trimble Centurion receiver located in the Computer lab

/pcode_aft_vtg - Course and speed over ground in NMEA VTG format from the Trimble Centurion receiver located in the Computer lab

/pcode_aft_zda - Time and date data in the NMEA ZDA format. Data retrieved from the Trimble Centurion receiver located in the Computer lab

/pcode_bridge_gga - Position data in NMEA GGA format from the Trimble GPS receiver located on the bridge.

/pcode_bridge_gll - Position data in NMEA GLL format from the Trimble GPS receiver located on the bridge.

/pcode_bridge_vtg - Course and speed over ground data in NMEA VTG format from the Trimble GPS receiver located on the bridge.

/posmv_gga - Position data in NMEA GGA format from the POS/MV

/posmv_gst - Pseudorange error statistics in NMEA GST format from the POS/MV

/posmv_hdt - Heading data in NMEA HDT format from the POS/MV

/posmv_pashr - Roll, pitch and heave from POS MV inertial navigation system.

/posmv_vtg - Course and speed over ground in NMEA VTG format from the POS/MV

/posmv_zda - Time and date data in NMEA ZDA format from the POS/MV

/rmyoung_air - Temperature, humidity, air pressure data in NMEA XDR format from the RM Young meteorological system

/rmyportwind - Wind speed and direction data in NMEA WMV format from the RM Young weather vane on the port side of the Healy.

/rmystbdwind - Wind speed and direction data in NMEA WMV format from the RM Young weather vane on the starboard side of the Healy.

/sbd_a_frame - Wire tension, wire out, and wire speed for the starboard A frame sheaves.

/seabeam_center - Center depth data from the Seabeam 2112

/sperry_speedlogbw - ground/water speed data from the Sperry Speed Log

/sv2000 - Sound Velocity data from the SV2000 sound velocimeter located in the ADCP BB150 sonar well

/true_wind_port - True wind speed data derived from gyro data and rmyportwind

/true_wind_stbd - True wind speed data derived from gyro data and rmystbdwind

/tsg_aft - Thermosalinograph and fluorometer data from the instruments in the Aft Fuel Hose room

/tsg_flow - Flow meter data just upstream of the TSG and Fluorometer

/tsg_fwd -Thermosalinograph and fluorometer data from the instruments in the Bio/Chem Lab

HLY0701 Data Synopsis

/winch_data - Line out and speed data from the winch system

/EventData – SCS 1 minute data. Data nearest the minute.

Meta_data:

Files describing data formats, Calibrations of Instruments, and the Data DVD descriptions are in this directory.

/elog - Contains the technician's narrative of important events, which occurred both to the network and to individual sensors.

/Bridge_Logs – Bridge logs kept by the bridge

DDMMMYY.doc - The "smooth log" containing events recorded by the bridge watch.

DDMMMYYWX.xls - Weather log recorded by the watch.

DDMMMYYNAV.xls - Navigation logs recorded by the watch.

./Systems_Calibration_Data – Calibration files for Sensors

/CTD_Sensors – CTD calibration files

/Underway_Sensors – Under way Sensor Calibration files

/Met_Sensors – Meteorological Calibration files

/Ocean_sensors – TSG Sensor Calibration files

/HLY0701_Sensors_files – Figures for HLY0701_Sensors.htm

Raw:

/ctd - CTD data in directories by Cast number.

/pos_mv - POS/MV and other navigation data. LDS logged data.

/tsg_fwd - Thermosalinograph/Fluorometer data from instruments in the Bio/Chem Lab in their raw format.

/tsg_aft - Thermosalinograph/Fluorometer data from instruments in the aft fuel hose room in their raw format.

/Optode - Oxygen concentration sensor run on HLY0701.

First DVD Contents by directory:

<u>Datalog:</u>		<u>Raw:</u>
ashtech_gll	posmv_gst	pos_mv
ashtech_gga	posmv_gga	pos_mv/events
ashtech_attitude	posmv_hdt	tsg_aft
ashtech_hdt	posmv_vtg	tsg_fwd
glonass_gga	posmv_zda	Ctd
	posmv_pashr	

HLY0701 Data Synopsis

glonass_gll	ibs_waypoints	Optode
gyro	tsg_aft	<u>Meta Data:</u>
pcode_bridge_gga	tsg_fwd	elog
pcode_bridge_gll	sv2000	Bridge_Logs
pcode_bridge_vtg	par	Systems_Calibration_Data
rmyportwind	air_temp_f	Systems_Calibration_Data/CTD_Sensors
pcode_aft_gga	dew_point_f	Systems_Calibration_Data/Underway_Sensors
pcode_aft_gll	true_wind_port	Systems_Calibration_Data/Underway_Sensors/MET_Sensors
pcode_aft_zda	true_wind_stbd	Systems_Calibration_Data/Underway_Sensors/Ocean_sensors
pcode_aft_vtg	par_derived	HLY0701_Sensors_files
rmyoung_air	aft_a_frame	
rmystbdwind	sbd_a_frame	
sperry_speedlog	EventData	
winch_data		
seabeam_center		
knudsen		

Directories on the second and subsequent DVDs:

Raw: This directory contains raw data as recorded by individual instruments and put into different directories. Directory names are labeled by the instrument name and string type of the data collected. A description of the data contained in this directory is below.

Images: This directory contains three directories of images from both the web cameras on board and Satellite data received during the cruise.

AloftConCam: This directory contains picture files separated by directories named by Day of YearDay (YYYYJJJ). The files are rolled over at midnight GMT. Some directories are empty as the DVDs are created. The picture files are in JPEG format.

FantailCam: This directory contains picture files separated by directories named by Day of YearDay (YYYYJJJ). The files are rolled over at midnight GMT. The base folder contains different files as well.

Satellite_Images: This directory contains images from Satellites collected over the cruise. They are in directories named for their content and further broken into directories named by YearMonthDay (YYYYMMDD).

Raw:

- /adcp75 - 75 KHz ADCP data
- /adcp150 - 150 Khz ADCP data
- /knudsenraw - Knudsen 320B/R data
- /seabeam - Seabeam 2112 data in the raw format.
- /xbt - Expendable Bathythermograph data.

Images:

Contains directories of Terascan, aloftconn and fantail cameras.

/AloftConCam - Contains picture files separated by folders named by Day of Year (YYYYJJJ) taken from a web camera in Aloft Con. The picture files are in JPEG format.

/FantailCam - Contains picture files separated by folders named by Day of Year (YYYYJJJ) taken from a web camera in Aft Con. The files are in JPEG format.

/Satellite_Image - Contains satellite imagery in jpeg format. Folder names are labeled as instrument name and string type of data collected

/dmisp - dmisp folders labeled by Year, Month, Day

/hrpt - hrpt folders labeled by Year, Month, Day

Second DVD Contents by directory:

<u>Images:</u>	Images/Satellite_Images/dmsp/20070409
Images/AloftConnCam	Images/Satellite_Images/dmsp/20070410
Images/AloftConnCam/2007099	Images/Satellite_Images/dmsp/20070411
Images/AloftConnCam/2007100	Images/Satellite_Images/dmsp/20070412
Images/AloftConnCam/2007101	Images/Satellite_Images/dmsp/20070413
Images/AloftConnCam/2007102	Images/Satellite_Images/dmsp/20070414
Images/AloftConnCam/2007103	Images/Satellite_Images/dmsp/20070415
Images/AloftConnCam/2007104	Images/Satellite_Images/dmsp/20070416
Images/AloftConnCam/2007105	Images/Satellite_Images/dmsp/20070417
Images/AloftConnCam/2007106	Images/Satellite_Images/dmsp/20070418
Images/AloftConnCam/2007107	Images/Satellite_Images/dmsp/20070419
Images/AloftConnCam/2007108	Images/Satellite_Images/hrpt
Images/AloftConnCam/2007109	Images/Satellite_Images/hrpt/20070409
Images/FantailCam	Images/Satellite_Images/hrpt/20070410
Images/FantailCam/2007099	Images/Satellite_Images/hrpt/20070411
Images/FantailCam/2007100	Images/Satellite_Images/hrpt/20070412
Images/FantailCam/2007101	Images/Satellite_Images/hrpt/20070413
Images/FantailCam/2007102	Images/Satellite_Images/hrpt/20070414
Images/FantailCam/2007103	Images/Satellite_Images/hrpt/20070415
Images/FantailCam/2007104	Images/Satellite_Images/hrpt/20070416
Images/FantailCam/2007105	Images/Satellite_Images/hrpt/20070417
Images/FantailCam/2007106	Images/Satellite_Images/hrpt/20070418
Images/FantailCam/2007107	Images/Satellite_Images/hrpt/20070419
Images/FantailCam/2007108	<u>Raw:</u>
Images/FantailCam/2007109	Raw/adcp75
Images/Satellite_Images	Raw/knudsenraw
Images/Satellite_Images/dmsp	Raw/seabeam

Merged Data

SCS One Minute Data File

The data are summarized into a one (1) minute data file in the SCS data logging system. This file takes the most recent value / current value to put into this summary. The data are the raw values as they are logged. There has been no quality control done on these files. Those wishing more accurate and quality controlled values should process the data in the directories described below.

This one minute data file was started at 4/14/07 at 06:00 UTC. Before this it was run intermittently with varying formats.

OneMinute_006.elg

04/17/2007,02:13:02,2007,04,17,021302.0046,0.011,350.7,353.761,351.022,351.3,11.0,60.48063,-
173.62621,0.00,740417.1526,-11.61, 72,1005.79, 2.418 , -1.709 , -1.176 , 2.580 , 31.94
,019.8,030,11.02,52.04,020,022.3,30.83,12.9,

04/17/2007,02:14:02,2007,04,17,021402.0031,0.011,15.8,18.902,016.071,10.3,10.9,60.48366,-
173.62641,65.12,729287.0451,-11.61, 72,1005.72, 2.564 , -1.709 , -1.184 , 2.580 , 31.95
,020.7,021,11.61,61.56,015,022.5,44.92,12.45,

04/17/2007,02:15:02,2007,04,17,021502.0015,0.011,14.2,17.273,014.326,12.8,10.5,60.48646,-
173.62500,66.09,719746.953,-11.48, 71,1005.64, 2.696 , -1.706 , -1.187 , 2.579 , 31.95
,023.2,024,14.46,51.27,015,025.4,39.88,16,

Field	DATA	Example	UNITS
01	SCS Logged Date	04/17/2007	
02	SCS Logged Time	02:12:02	GMT
03	POSMV-Year	2007	yyyy
04	POSMV-Month	,04	MM
05	POSMV-Day	17	DD
06	POSMV-Time	021202.0012	HHMMSS.ss
07	POSMV-Heading-Accuracy	0.011	deg
08	POSMV-Heading	349.5	deg
09	Gyro-HDT	352.423	deg
10	ADU-HDT	349.824	deg
11	POSMV-COG	347.1	deg
12	POSMV-SOG	10.7	Knots
13	POSMV-LAT	60.47765	deg
14	POSMV-LON	,-173.62502	deg
15	SB-Depth	65.33	Meters
16	PAR-derived-Value	751547.2602	uEinstein/m2.s
17	RMY-Temp	,-11.61	Deg. C

HLY0701 Data Synopsis

Field	DATA	Example	UNITS
18	RMY-Humidity	71	Percent
19	RMY-Baro	1005.79	millibars
20	SCUFA-MG/L	2.381	ppm
21	TSGF-SST	-1.711	C
22	TSGF-IntTemp	-1.175	C
23	TSGF-Cond	2.580	
24	TSGF-Sal	31.95	ppt
25	StbdWndSpd-R	015.3	Knots
26	StbdWndDir-R	041	Deg
27	StbdWnd-T-Speed	10.52	
28	StbdWnd-T-Direction	74.83	
29	PortWndDir-R	033	Deg
30	PortWndSpd-R	018.2	Knots
31	PortWnd-T-Direction	57.33	
32	PortWnd-T-Speed	10.33	

LDEO Averaged One Minute Data File

The data are summarized into an averaged one (1) minute data file by the LDEO technician. This file takes the average value centered around the minute, (30 seconds either side of the whole minute). The data are the raw values as they are logged. There has been no quality control done on these files. Those wishing more accurate and quality controlled values should process the data in the directories described below in the document.

Note 1:

SCUFA_FI_V scale at 2007/04/13 03:35:08 was changed from 0-80ug/l to 0-30ug/l.

SCUFA_FI_V prior to this time was multiplied by "80/30" in this file.

$$\text{SCUFA_CHL} = \text{SCUFA_FI_V} \times 6$$

Note *2:

Turbidity was not added as a sensor until around 2007/04/13 4:30.

Turb_Volts scale at 2007/04/16 21:47:51 was changed from 0-5NTU to 0-10NTU.

Turb_Volts prior to this time was divided by 2 in this file.

$$\text{SCUFA_Turb} = \text{Turb_Volts} \times 2$$

HLY0701_one_minute.data

24945,2007/04/28 04:33,-169.866590,56.651784,11.4,21.7,20.9,82.3,1.998,2.847,32.12,1.668,2.416,0.403,0.557,0.279,22,02,-200,26,0,01,-130,-5,0,-1.55,70,-6.33,1003.60,3.91,72.2,4.56,87.4,532722.519

24946,2007/04/28 04:34,-169.864457,56.654721,11.4,22.0,21.1 81.8,1.980,2.845,32.11,1.648,2.352,0.392,0.554,0.277,22,02,-200,26,0,01,-140,-5,0,-1.60,70,-6.33,1003.60,4.53,62.7,4.91,79.9,519890.107

24947,2007/04/28 04:35,-169.862317,56.657645,11.4,22.0,20.8,81.0,1.971,2.844,32.11,1.649,2.261,0.377,0.550,0.275,22,02,-200,26,0,01,-140,-5,0,-1.59,70,-6.40,1003.60,4.12,56.7,4.48,71.5,514033.101

Field	DATA	Example	UNITS
01	ID	24950	samplecount
02	date	2007/04/28 04:38	date&timeUTC (year/month/dayhour:minute)
03	lon	-169.855928	POSMVLongitude (decimaldegrees)
04	lat	56.666416	POSMVLatitude (decimaldegrees)
05	sog	11.4	POSMVSpeedOverGround (Knots,1minuteaverage)
06	cog	22.0	POSMVCourseOverGround (angulardistancefrom0 (North) clockwisethrough360,1minuteaverage)

HLY0701 Data Synopsis

Field	DATA	Example	UNITS
07	heading	20.7	POSMVshipheading (angulardistancefrom0 (North) clockwisethrough360,1minuteaverage)
08	depth	80.3	Seabeamcenterbeamdepth (meters,1minuteaverage)
09	TSGF_InTemp	1.968	SBE21internaltemperature (Celsius,1minuteaverage)
10	TSGF_Cond	2.843	Conductivity (Siemens/meter,1minuteaverage)
11	TSGF_Sal	32.10	Salinity (PSU,1minuteaverage)
12	TSGF_SST	1.612	RemoteTemperature,SeaChestintake (Celsius,1minuteaverage)
13	SCUFA_CHL	2.111	SCUFAFluorometer (Ug/l,1minuteaverage)
14	SCUFA_FI_V	0.352	SCUFAFluorometer (Volts,1minuteaverage)*
15	SCUFA_Turb	0.540	SCUFATurbidity (NTU,1minuteaverage)
16	Turb_Volts	0.270	SCUFATurbidity (Volts,1minuteaverage)**
17	tsg_flow	22	FlowmeterfeedingTSGandFLUOR (Liters/minute)
18	WinchAft	02	AftA-FrameWinchnumber
19	TensionAft	-200	AftA-FrameWinchWiretension (Pounds)
20	WireOutAft	26	AftA-FrameWinchWireout(Meters)
21	SpeedAft	0	AftA-FrameWinchWirespeed (Meters/minute)
22	WinchSbd	01	StarboardA-FrameWinchnumber
23	TensionSbd	-120	StarboardA-FrameWinchWiretension (Pounds)
24	WireOutSbd	-11	StarboardA-FrameWinchWireout (Meters)
25	SpeedSbd	0	StarboardA-FrameWinchWirespeed (Meters/minute)
26	RMYTemp	-1.70	RMYoungAirTemperature (Celsuis,1minuteaverage)
27	RMYHumidity	69	RMYoungRelativeHumidity (Precent,1minuteaverage)
28	RMYDewPt	-6.58	RMYoungDewPointTemperature (Celcius,1minuteaverage)
29	RMYBaro	1003.55	RMYoungBarometer

HLY0701 Data Synopsis

Field	DATA	Example	UNITS
			(hPa, 1minuteaverage)
30	PortWndSpdT	4.57	RMYoungWindSpeed,port (Knots, 1minuteaverage)
31	PortWndDirT	62.7	RMYoungWindDirection,port (angulardistancefrom0 (North) clockwisethrough360, 1minuteaverage)
32	StbdWndSpdT	4.83	RMYoungWindSpeed,starboard (Knots, 1minuteaverage)
33	StbdWndDirT	81.5	RMYoungWindDirection,starboard (angulardistancefrom0 (North) clockwisethrough360, 1minuteaverage)
34	PARderived	505144.287	DerivedsurfacePAR (Microeinstens/m2sec, 1minuteaverage)

Underway Sensors

Sensor	Description		Status
Meteorology & Radiometers			
Port Anemometer	RM Young 09101	Continuous	Collected
Stbd Anemometer	RM Young 5106	Continuous	Collected
Barometer	RM Young 61201	Continuous	Collected
Air Temp/Rel. Hum.	RM Young 41382VC	Continuous	Collected
Helo shack PAR	BSI QSR-2200	Continuous	Collected
Underway Ocean			
TSG	SeaBird SBE21	Continuous	Collected
Remote Sea Temp	SeaBird SBE3S	Continuous	Collected
Fluorometer	Turner SCUFA	Continuous	Collected
Sonars			
Knudsen-subbottom	320 B/R	Continuous	Collected
ADCP 150 kHz	Broad Band (BB150)	Continuous	Not Collected
ADCP 75 kHz	Ocean Surveyor	Continuous	Collected
Multibeam	Seabeam 2112	Continuous	Collected
Speed log	Sperry	Continuous	Collected
Navigation			
P-Code GPS (aft)	Trimble Centurion	Continuous	Collected
Attitude GPS	Ashtech ADU5	Continuous	Collected
DGPS	Trimble AGGPS-AG132	Continuous	Collected
POSMV	Model- MV V4	Continuous	Collected
P-Code GPS (fwd)	?	Continuous	Collected
Glomass	?	Continuous	Collected
GYRO 1	Sperry MK25	Continuous	Collected
GYRO 2	Sperry MK25	Continuous	Collected

File Formats of Data Collected on HLY0701

In the sections below for each data type the directory name is listed, then an example file name, and then 3 lines from that file. This part is followed by a table that lists the data contained in the string.

./Datalog

The following data types are to be found in the DataLog directory of the DVD.

Under way Data

Meteorology Data

R. M. Young Sensors

R.M. Young Air Temperatures

Temperature, humidity, air pressure data in NMEA XDR format from the RM Young meteorological system.

./rmyoung_air

RMYoung-Air_20070414-182437.Raw

04/14/2007,18:24:40.693,\$WIXDR,C,-6.62,C,1,H,89,P,1,C,-8.06,C,1,P,994.24,B,2,D,-35,M,3hh

04/14/2007,18:24:46.677,\$WIXDR,C,-6.49,C,1,H,89,P,1,C,-7.93,C,1,P,994.32,B,2,D,-35,M,3hh

04/14/2007,18:24:49.678,\$WIXDR,C,-6.49,C,1,H,89,P,1,C,-7.93,C,1,P,994.24,B,2,D,-35,M,3hh

FIELD	DATA	Example	UNITS
1	SCS logged Date	04/14/2007	mm/dd/year
2	SCS logged Time GMT	18:24:49.678	hh:mm:ss.sss
3	NMEA header	,\$WIXDR	
3	Data type for field 5	C	Temperature
5	Air Temperature	-6.49	Celsius
8	Data Type for field 9	H	
9	Relative Humidity	89	Percent
12	Data type for field 13	C	
13	Dew Point Temperature	-7.93	Celcius
16	Data type for field 17	P	Pressure
17	Barometer	994.24	hPa
20	Data type for field 20	D	
21	Elevation	-35	Meters

R.M. Young Air Temperatures, Fahrenheit (Derived)

Temperature data from the RM Young wind sensor in Fahrenheit. Data is derived from data from files in the rmyoung_air directory.

./ air_temp_f

AirTemp-F_20070413-000000.Raw

04/13/2007,00:00:02.074,\$DERIV,28.83,-1.76,

04/13/2007,00:00:05.074,\$DERIV,28.62,-1.88,

04/13/2007,00:00:08.074,\$DERIV,28.62,-1.88,

FIELD	DATA	Example	UNITS
1	SCS logged Date	04/14/2007	mm/dd/year
2	SCS logged Time GMT	18:24:49.678	hh:mm:ss.sss
3	NMEA header	,\$DERIV	
4	Air Temperature	28.83	Fahrenheit
5	Air Temperature	-1.76	Celsius

R.M. Young Wind. Port

Wind speed and direction data in NMEA WMV format from the RM Young weather vane on the port side of the Healy.

./rmyportwind

RMYPortWind_20070414-182437.Raw

04/14/2007,18:24:38.490,\$WIMWV,033,R,028.1,N,A*36

04/14/2007,18:24:39.505,\$WIMWV,041,R,028.7,N,A*35

04/14/2007,18:24:40.521,\$WIMWV,034,R,029.4,N,A*35

FIELD	DATA	Example	UNITS
1	SCS logged Date	04/14/2007	mm/dd/year
2	SCS logged Time GMT	18:24:40.521	hh:mm:ss.sss
3	NMEA header	\$WIMWV	
4	Wind Direction	034	Degrees
5	R= Relative	R	
6	Wind Speed	029.4	Knots
7	N= Knots	N	
8	A= Valid Data	A	
9	Check sum	*35	

R.M. Young Wind, Starboard

Wind speed and direction data in NMEA WMV format from the RM Young weather vane on the starboard side of the Healy.

./rmstbwind

RMYSbtdWind_20070414-182437.Raw

04/14/2007,18:24:38.677,\$WIMWV,044,R,025.4,N,A*3E

04/14/2007,18:24:39.693,\$WIMWV,045,R,025.6,N,A*3D

04/14/2007,18:24:40.724,\$WIMWV,042,R,025.2,N,A*3E

FIELD	DATA	Example	UNITS
1	SCS logged Date	04/14/2007	mm/dd/year
2	SCS logged Time GMT	18:24:40.724	hh:mm:ss.sss
3	NMEA header	\$WIMWV	
4	Wind Direction	042	Degrees
5	R= Relative	R	
6	Wind Speed	025.2	Knots
7	N= Knots	N	
8	A= Valid Data	A	
9	Check sum	*3E	

R.M. Young Wind True, Port (Derived)

True wind speed data derived from gyro data and rmyportwind.

./true_wind_port

PortWnd-T_20070415-000000.Raw

04/15/2007,00:00:03.927,\$DERIV,18.59,4.57,30.6,12,12.5,343.7,344.2,

04/15/2007,00:00:05.927,\$DERIV,19.69,10.28,31.4,16,12.5,344.2,344.2,

04/15/2007,00:00:07.927,\$DERIV,19.85,3.73,31.8,12,12.4,344.1,344.2,

FIELD	DATA	Example	UNITS
1	SCS logged Date	04/15/2007	mm/dd/year
2	SCS logged Time GMT	00:00:07.927	hh:mm:ss.sss
3	NMEA header	\$DERIV	
5	Wind Speed derived	19.85	knots
8	Wind Directions derived	3.73	degrees
9	Wind Speed relative	31.8	knots
12	Wind Direction relative	12	direction
13	Speed over ground (pos mv)	12.4	knots
16	Course over ground (pos mv)	344.1	Degrees
17	Heading (pos mv)	344.2	Degrees

R.M. Young Wind True, Starboard (Derived)

True wind speed data derived from gyro data and rmystbdwind.

./true_wind_stbd

StbdWnd-T_20070415-000000.Raw

04/15/2007,00:00:03.396,\$DERIV,17.33,3.47,29.4,11,12.5,343.7,344.2,

04/15/2007,00:00:05.396,\$DERIV,17.05,15.29,28.5,18,12.5,344.2,344.2,

04/15/2007,00:00:07.396,\$DERIV,19.99,13.31,31.4,18,12.4,344.1,344.2,

FIELD	DATA	Example	UNITS
1	SCS logged Date	04/15/2007	mm/dd/year
2	SCS logged Time GMT	00:00:07.396	hh:mm:ss.sss
3	NMEA header	\$DERIV	
5	Wind Speed derived	19.99	knots
8	Wind Directions derived	13.31	degrees
9	Wind Speed relative	31.4	knots
12	Wind Direction relative	18	direction
13	Speed over ground (pos mv)	12.4	knots
16	Course over ground (pos mv)	344.1	Degrees
17	Heading (pos mv)	344.2	degrees

Dew Point (Derived)

Dew Point derived from rmyoung_air.

./dew_point_f

DewPt-F_20070414-182437.Raw

04/14/2007,18:24:41.099,\$DERIV,17.49,-8.06,

04/14/2007,18:24:44.099,\$DERIV,17.73,-7.93,

04/14/2007,18:24:47.099,\$DERIV,17.73,-7.93,

FIELD	DATA	Example	UNITS
1	SCS logged Date	04/14/2007	mm/dd/year
2	SCS logged Time GMT	18:24:47.099	hh:mm:ss.sss
3	NMEA header	\$DERIV	
4	Air Temperature	17.73	Fahrenheit
7	Air Temperature	-7.93	Celsius

Photosynthetic Active Radiation (PAR) Sensor

PAR

Photosynthetic Active Radiation volts from the surface par sensor.

./par

PAR_20070415-000000.Raw

04/15/2007,00:00:03.068,+01126.24

04/15/2007,00:00:04.068,+01133.28

04/15/2007,00:00:05.068,+01140.96

FIELD	DATA	Example	UNITS
1	SCS logged Date	04/15/2007	mm/dd/year
2	SCS logged Time GMT	00:00:05.505	hh:mm:ss.sss
3	PAR	+01140.96	mVolts

PAR (Derived)

Photosynthetic Active Radiation, Microeinstens/m2 sec from surface par sensor.

Par_derived

PAR-derived_20070415-000000.Raw

04/15/2007,00:00:03.146,\$DERIV,1865353.0198,1126.24,

04/15/2007,00:00:09.146,\$DERIV,1909343.4448,1152.8,

04/15/2007,00:00:15.146,\$DERIV,1881518.176,1136,

FIELD	DATA	Example	UNITS
1	SCS logged Date	04/15/2007	mm/dd/year
2	SCS logged Time GMT	00:00:05.193	hh:mm:ss.sss
3	NMEA header	\$DERIV	
4	Derived surface PAR	1881518.176	Microeinstens/m2 sec
5	PAR volts	1136	mVolts

Oceanographic Data

Thermosalinograph / Fluorometer

AFT Theromosalinograph / Fluorometer

Thermosalinograph and Fluorometer data from the instruments in the Aft Fuel Hose room.

./tsg_aft

TSGAFT_20070414-182437.Raw

NO DATA

Forward Theromosalinograph Flowmeter

Flowmeter data from the instruments in the Bio/Chem Lab

./tfg_flow.

TSGF-FlowMeter_20070415-000000.Raw

04/15/2007,00:00:02.974, 11.

04/15/2007,00:00:09.255, 11.

04/15/2007,00:00:15.537, 11.

FIELD	DATA	Example	UNITS
1	SCS logged Date	04/15/2007	mm/dd/year
2	SCS logged Time GMT	00:00:15.537	hh:mm:ss.sss
3	Flowmeter feeding TSG and FLUOR	11.	Liters/minute

Forward Thermosalinograph / Fluorometer

Thermosalinograph and Fluorometer data from instruments in the Bio Chem Lab. . Also see the appendix section “SBE 21 SEACAT Thermosalinograph Data Output Formats”.

Note 1:

SCUFA_FI_V scale at 2007/04/13 03:35:08 was changed from 0-80ug/l to 0-30ug/l.

SCUFA_FI_V prior to this time was multiplied by "80/30" in this file.

SCUFA_CHL = SCUFA_FI_V x 6

Note *2:

Turbidity was not added as a sensor until around 2007/04/13 4:30.

Turb_Volts scale at 2007/04/16 21:47:51 was changed from 0-5NTU to 0-10NTU.

Turb_Volts prior to this time was divided by 2 in this file.

SCUFA_Turb = Turb_Volts x 2

Before 4/13/07 05:26

./tsg_fwd

TSGFWD_20070413-000000.Raw

Prior to output changes made on 4-13-07 at 5:26:00 (see elog for details)

04/13/2007,05:22:22.767,	11	0.021	2.663	31.79	-0.397	1443.001	9.921
04/13/2007,05:22:28.767,	12	0.019	2.663	31.80	-0.398	1443.002	9.786
04/13/2007,05:22:34.767,	13	0.020	2.663	31.79	-0.397	1443.004	9.695

FIELD	DATA	Example	UNITS
1	SCS logged Date	04/13/2007	mm/dd/year
2	SCS logged Time GMT	05:22:34.767	hh:mm:ss.sss
3	Scan number	13	
4	SBE 21 internal temperature	0.020	Celsius
5	Conductivity	2.663	Siemens/meter
6	Salinity	31.79	PSU
7	RemoteTemperature (Sea Chest intake)	-0.397	Celsius
8	Sound Velocity	1443.004	Meters per Second (m/s)
9	Fluorometer (SCUFA)	9.695	Ug/l

After 4/13/07 05:26

./tsg_fwd

TSGFWD_20070415-000000.Raw

After output changes made on 4-13-07 at 5:26:00 (see elog for details)

```
04/15/2007,00:00:04.255, 25269 -0.838 2.577 31.56 -1.457 1437.661
    3.321 0.664 4.617 4.617
04/15/2007,00:00:10.287, 25270 -0.850 2.577 31.57 -1.458 1437.672
    3.474 0.695 5.000 5.000
04/15/2007,00:00:16.255, 25271 -0.848 2.577 31.56 -1.458 1437.664
    3.339 0.668 4.927 4.927
```

FIELD	DATA	Example	UNITS
1	SCS logged Date	04/15/2007	mm/dd/year
2	SCS logged Time GMT	00:00:16.255	hh:mm:ss.sss
3	Scan number	25271	
4	SBE 21 internal temperature	-0.848	Celsius
5	Conductivity	2.577	Siemens/meter
6	Salinity	31.56	PSU
7	RemoteTemperature (Sea Chest intake)	-1.458	Celsius
8	Sound Velocity	1437.664	Meters per Second (m/s)
9	Fluorometer (SCUFA)	3.339	Ug/l
10	Fluorometer (SCUFA)	0.668	Volts
11	Turbidity (SCUFA)	4.927	NTU
12	Turbidity (SCUFA)	4.927	Volts

Sonar Data

Seabeam 2112 Center Beam

Center depth data derived from the Seabeam 2112 data on the POSMVNAV computer.

./seabeam_center

Seabeam-Centerbeam_20070414-182437.Raw

04/14/2007,18:24:38.427,\$SBCTR,2007,4,14,18:24:35.713,58.119110,-169.839278,70.70,60*00

04/14/2007,18:24:40.177,\$SBCTR,2007,4,14,18:24:37.213,58.119152,-169.839367,70.49,61*00

04/14/2007,18:24:40.615,\$SBCTR,2007,4,14,18:24:38.734,58.119193,-169.839452,70.92,60*00

FIELD	DATA	Example	UNITS
1	SCS logged Date	04/14/2007	mm/dd/year
2	SCS logged Time GMT	18:24:40.615	hh:mm:ss.sss
3	NMEA header	,\$SBCTR	
4-6	Seabeam Date	2007,4,14	Year,month,day
7	Seabeam Time	18:24:38.734	hh:mm:ss.sss
8	Latitude	58.119193	Degrees
9	Longitude	-169.839452	Degrees
10	Depth	70.92	meters
11	Number of Beams	60	
12	Check sum	*00	

Knudsen

3.5 kHz

Depth data in a proprietary PKEL format received from Knudsen 320 B/R serial output.

./knudsen

Knudsen_20070414-182437.Raw

04/14/2007,18:24:38.099,\$PKEL99,-----
 ,14042007,182524.248,00192,HF,00.00,0,+008.50,LF,73.24,1,+008.50,1500,-----,----,58
 07.123897N,169 50.315830W,1060*12

04/14/2007,18:24:38.349,\$PKEL99,-----
 ,14042007,182525.759,00191,HF,00.00,0,+008.50,LF,73.22,1,+008.50,1500,-----,----,58
 07.127267N,169 50.322883W,0565*1F

04/14/2007,18:24:39.865,\$PKEL99,-----
 ,14042007,182527.269,00191,HF,00.00,0,+008.50,LF,73.22,1,+008.50,1500,-----,----,58
 07.128948N,169 50.326409W,1078*10

FIELD	DATA	Example	UNITS
1	SCS logged Date	04/14/2007	mm/dd/year
2	SCS logged Time GMT	18:24:39.865	hh:mm:ss.sss
3	NMEA header	\$PKEL99	KEL Proprietary Data String
4	Record Number???	-----	
5	Knudsen Date	14042007	DDMMYYYY
6	Knudsen Time	182527.269	HHMMSS.sss
7		00191	
8	HF Header (12 kHz)	HF	
9	HF Depth to Surface	00.00	Meters *
10	HF Draft	,+008.50	Meters
11	LF Header	LF	
12	LF Depth to Surface	73.22	Meters *
13	LF Depth Valid Flag	1	
14	LF Draft	+008.50	Meters
15	Sound Speed	1500	Meters Per Second**
18	Latitude	58 07.128948N	DD MM.MMMMMM***
19	Longitude	169 50.326409W	DDD MM.MMMMMM***
20	Position Latency	1078	
21	Checksum	*10	

* Knudsen depth is currently set for Meters

** Knudsen default sound speed

*** Current GPS source is the POS/MV

Winch data

Starboard A-Frame Winch Data

1 second data from the Starboard A Frame winch data output.

`./sbd_a_frame`

Stbd-A-Frame_20070418-000000.Raw

04/18/2007,06:13:18.281,01, 890,, 36,, -27,,0000

04/18/2007,06:13:19.250,01, 890,, 35,, -28,,0000

04/18/2007,06:13:20.235,01, 900,, 35,, -28,,0000

FIELD	DATA	Example	UNITS
1	SCS logged Date	04/18/2007	mm/dd/year
2	SCS logged Time GMT	06:13:20.235	hh:mm:ss.sss
3	Winch number	01	
4	Wire tension	900	Pounds
5	Wire out	35	Meters
7	Wire speed	-28	Meters/minute

Aft A-Frame Winch Data

1 second data from the Aft A Frame winch data output.

`./aft_a_frame`

Aft-A-Frame_20070418-000000.Raw

04/18/2007,08:46:45.844,02, -160,, 31,, 58,,0000

04/18/2007,08:46:46.844,02, -160,, 32,, 60,,0000

04/18/2007,08:46:47.812,02, -160,, 33,, 60,,0000

FIELD	DATA	Example	UNITS
1	SCS logged Date	04/18/2007	mm/dd/year
2	SCS logged Time GMT	08:46:47.812	hh:mm:ss.sss
3	Winch number	02	
4	Wire tension	-160	Pounds
5	Wire out	33	Meters
7	Wire speed	60	Meters/minute

Navigational Data

POSMV

The POSMV device is located above the Helo Control Shack. The results are corrected to the Master Reference Point (MRP) for the ship. See the Instrument Locations on the Healy section in the Appendix.

POSMV GGA

Position data in NMEA GGA format from the POS/MV.

./posmv_gga

POSMV-GGA_20070415-000000.Raw

04/15/2007,00:00:03.052,\$INGGA,000002.737,5830.47054,N,17012.64182,W,2,08,1.0,1.80,M,,4,0297*07

04/15/2007,00:00:04.052,\$INGGA,000003.737,5830.47385,N,17012.64365,W,2,08,1.0,1.76,M,,5,0297*0A

04/15/2007,00:00:05.052,\$INGGA,000004.737,5830.47716,N,17012.64550,W,2,08,1.0,1.71,M,,6,0297*07

FIELD	DATA	Example	UNITS
1	SCS logged Date	04/15/2007	mm/dd/year
2	SCS logged Time GMT	00:00:05.052	hh:mm:ss.sss
3	NMEA header	\$INGGA	
4	GPS time at position GMT	000004.737	hhmmss.sss
5	Latitude	5830.47716	ddmm.mmmmm
6	North (N) or South(S)	N	
7	Longitude	17012.64550	dddmm.mmmmm
8	East (E) or West (W)	W	
9	GPS Quality: 1 = GPS2=DGPS	2	
10	Number of GPS Satellites Used	08	
11	HDOP (horizontal dilution of precision)	1.0	
12	Antenna height	1.71	meters
13	M for Meters	M	
14	Geoidal Height		meters
15	M for Meters		
16	Differential reference station ID	0297	
17	Checksum	*07	

POSMV Psuedo Noise

Psuedorange error statistics in NMEA GST format from the POS/MV.

./posmv_gst

POSMV-Pseudo-Noise_20070415-000000.Raw

04/15/2007,00:00:02.990,\$INGST,000002.737,,0.6,0.4,22.3,0.4,0.6,0.8*63

04/15/2007,00:00:03.990,\$INGST,000003.737,,0.6,0.4,22.3,0.4,0.6,0.8*62

04/15/2007,00:00:04.990,\$INGST,000004.737,,0.6,0.4,22.3,0.4,0.6,0.8*65

FIELD	DATA	Example	UNITS
1	SCS logged Date	04/15/2007	mm/dd/year
2	SCS logged Time GMT	00:00:05.052	hh:mm:ss.sss
3	NMEA header	\$INGST	
4	GPS time at position GMT	000004.737	hhmmss.sss
5			
6	Smjr.smjr	0.6	
7	Smnr.smnr	0.4	
8	000.0	22.3	
9	l.l	0.4	
10	y.y	0.6	
11	Standard deviation of altitude (a.a)	0.8	meters
12	Checksum	*65	

POSMV HDT

Heading data in NMEA HDT format from the POS/MV.

./posmv_hdt

POSMV-HDT_20070415-000000.Raw

04/15/2007,00:00:03.083,\$INHDT,344.2,T*24

04/15/2007,00:00:04.083,\$INHDT,344.2,T*24

04/15/2007,00:00:05.083,\$INHDT,344.2,T*24

FIELD	DATA	Example	UNITS
1	SCS logged Date	04/15/2007	mm/dd/year
2	SCS logged Time GMT	00:00:05.083	hh:mm:ss.sss
3	NMEA header	\$INHDT	
4	Heading	344.2	Degrees
5	True(T) or Magnetic(M)	T	
6	Checksum	*24	

POSMV PASHR

Pitch and Roll data in NMEA PASHR format from the POS/MV.

./posmv_pashr

POSMV-PASHR_20070415-000000.Raw

04/15/2007,00:00:02.912,\$PASHR,000002.737,344.17,T,-0.21,0.10,-0.02,0.017,0.017,0.011,2,1*17

04/15/2007,00:00:03.912,\$PASHR,000003.737,344.19,T,-0.22,0.10,-0.02,0.017,0.017,0.011,2,1*1B

04/15/2007,00:00:04.912,\$PASHR,000004.737,344.20,T,-0.24,0.10,-0.02,0.017,0.017,0.011,2,1*10

FIELD	DATA	Example	UNITS
1	SCS logged Date	04/15/2007	mm/dd/year
2	SCS logged Time GMT	00:00:05.052	hh:mm:ss.sss
3	NMEA header	\$PASHR	
4	Time GMT	000004.737	hhmmss.sss
5	Heading	344.20	heading
6	True	T	
7	Roll	-0.24	Degrees
8	Pitch	0.10	Degrees
9	Heave	-0.02	Degrees
10	Accuracy roll	0.017	Degrees
11	Accuracy pitch	0.017	Degrees
12	Accuracy heading	0.011	Degrees
13	Accuracy of heading 0=no aiding, 1-GPS 2= GPS & GAMS	2	
14	IMU 0= out 1= satisfactory	1	
15	Check Sum	*10	

POSMV VTG

Course and speed over ground in NMEA VTG format from the POS/MV.

./posmv_vtg

POSMV-VTG_20070415-000000.Raw

04/15/2007,00:00:03.130,\$INVTG,343.7,T,,M,12.5,N,23.1,K*75

04/15/2007,00:00:04.130,\$INVTG,344.0,T,,M,12.5,N,23.1,K*75

04/15/2007,00:00:05.115,\$INVTG,344.2,T,,M,12.5,N,23.1,K*77

FIELD	DATA	Example	UNITS
1	SCS logged Date	04/15/2007	mm/dd/year
2	SCS logged Time GMT	00:00:05.115	hh:mm:ss.sss
2	NMEA header	\$INVTG	
3	Heading	344.2	Degrees
4	Degrees true (T)	T	
5	Heading		Degrees
6	Degrees magnetic	M	
7	Ship Speed	12.5	knots
8	N=Knots	N	
9	Ship Speed	23.1	km/hr
10	K=KM per hour	K	
11	Check sum	*77	

POSMV ZDA

Time and date data in NMEA ZDA format from the POS/MV.

./posm_zda

POSMV-ZDA_20070415-000000.Raw

04/15/2007,00:00:03.162,\$INZDA,000003.0016,15,04,2007,,*77

04/15/2007,00:00:04.162,\$INZDA,000004.0016,15,04,2007,,*70

04/15/2007,00:00:05.162,\$INZDA,000005.0016,15,04,2007,,*71

FIELD	DATA	Example	UNITS
1	SCS logged Date	04/15/2007	mm/dd/year
2	SCS logged Time GMT	00:00:05.162	hh:mm:ss.sss
2	NMEA header	\$INZDA	
3	Time UTC	000005.0016	HHMMSS.ssss
4	Day	15	DD
5	Month	04	MM
6	Year	2007	Year
7	??		??
8	??	00	??
9	Checksum	*71	

Ashtech GPS

Ashtech Attitude

Attitude in NMEA format from the Ashtech ADU5 GPS receiver.

./ashtech_attitude

Ashtech-Attitude_20070415-000000.Raw

04/15/2007,00:00:03.490,\$GPPAT,000003.00,5830.44196,N,17012.62728,W,00030.21,344.3730,000.25,-000.01,0.0015,0.0074,0*42

04/15/2007,00:00:04.490,\$GPPAT,000004.00,5830.44527,N,17012.62914,W,00030.23,344.3537,000.20,-000.06,0.0015,0.0071,0*4A

04/15/2007,00:00:05.490,\$GPPAT,000005.00,5830.44859,N,17012.63099,W,00030.23,344.3431,000.22,-000.07,0.0014,0.0077,0*41

FIELD	DATA	Example	UNITS
1	SCS logged Date	04/15/2007	mm/dd/year
2	SCS logged Time GMT	00:00:05.490	hh:mm:ss.sss
3	NMEA header	\$GPPAT	
4	GPS time at position GMT	000005.00	hhmmss.ss
5	Latitude	5830.44859	ddmm.mmmmm
6	North (N) or South(S)	N	
7	Longitude	17012.63099	dddmm.mmmmm
8	East (E) or West (W)	W	
9	Altitude	00030.23	Meters
10	Heading	344.3431	Degrees
11	Pitch	000.22	Degrees
12	Roll	-000.07	degrees
13	Attitude phase measurement rms error, MRMS	0.0014	meters
14	Attitude baseline length rms error, BRMS	0.0077	meters
15	Attitude reset flag (0:good attitude, 1:rough estimate or bad attitude)	0	
16	Check sum	*41	

Ashtech GGA

Position data in NMEA GGA format from the Ashtech ADU5 GPS receiver.

./ashtech_gga

Ashtech-GGA_20070415-000000.Raw

04/15/2007,00:00:02.333,\$GPGGA,000002.00,5830.43864,N,17012.62542,W,1,13,0.7,20.74,M,9.47,M,,*73

04/15/2007,00:00:03.333,\$GPGGA,000003.00,5830.44196,N,17012.62728,W,1,13,0.7,20.75,M,9.47,M,,*7E

04/15/2007,00:00:04.333,\$GPGGA,000004.00,5830.44527,N,17012.62914,W,1,13,0.7,20.76,M,9.47,M,,*75

FIELD	DATA	Example	UNITS
1	SCS logged Date	04/15/2007	mm/dd/year
2	SCS logged Time GMT	00:00:04.333	hh:mm:ss.sss
3	NMEA header	\$GPGGA	
4	GPS time at position GMT	000004.00	hhmmss.ss
5	Latitude	5830.44527	ddmm.mmmmm
6	North (N) or South(S)	N	
7	Longitude	17012.62914	dddmm.mmmmm
8	East (E) or West (W)	W	
9	GPS Quality: 1 = GPS2=DGPS	1	
10	Number of GPS Satellites Used	13	
11	HDOP (horizontal dilution of precision)	0.7	
12	Antenna height	20.76	meters
13	M for Meters	M	
14	Geoidal Height	9.47	meters
15	M for Meters	M	
16	Differential reference station ID (no data in sample string)		
17	Checksum	*75	

Ashtech GGL

Position data in NMEA GLL format from the Ashtech ADU5 GPS receiver.

./ashtech_ggl

Ashtech-GLL_20070415-000000.Raw

04/15/2007,00:00:03.271,\$GPGLL,5830.44196,N,17012.62728,W,000003.00,A,A*74

04/15/2007,00:00:04.255,\$GPGLL,5830.44527,N,17012.62914,W,000004.00,A,A*7C

04/15/2007,00:00:05.255,\$GPGLL,5830.44859,N,17012.63099,W,000005.00,A,A*74

FIELD	DATA	Example	UNITS
1	SCS logged Date	04/15/2007	mm/dd/year
2	SCS logged Time GMT	00:00:05.255	hh:mm:ss.sss
3	NMEA header	\$GPGLL	
4	Latitude	5830.44859	ddmm.mmmmm
5	North or South	N	
6	Longitude	17012.63099	dddmm.mmmmm
7	East or West	W	
8	GMT of Position	000005.00	hhmmss.ss
9	Status of data (A=valid)	A	
10	???	A	
11	Checksum	*74	

Ashtech HDT

Heading data in NMEA HDT format from the Ashtech ADU5 GPS receiver.

./ashtech_hdt

Ashtech-HDT_20070415-000000.Raw

04/15/2007,00:00:03.505,\$GPHDT,344.373,T*31

04/15/2007,00:00:04.505,\$GPHDT,344.354,T*34

04/15/2007,00:00:05.505,\$GPHDT,344.343,T*32

FIELD	DATA	Example	UNITS
1	SCS logged Date	04/15/2007	mm/dd/year
2	SCS logged Time GMT	00:00:05.505	hh:mm:ss.sss
3	NMEA header	\$GPHDT	
4	Heading	344.343	Degrees
5	True(T) or Magnetic(M)	T	
6	Checksum	*32	

PCode

PCode AFT

PCode Aft GGA

Position data in NMEA GGA format from the Trimble Centurion receiver located in the Computer lab.

./pcode_aft_gga

PCode-AFT-GGA_20070415-000000.Raw

04/15/2007,00:00:03.443,\$GPGGA,000002.522,5830.4417,N,17012.6249,W,1,04,1.5,019.8,M,-008.9,M,,*51

04/15/2007,00:00:04.427,\$GPGGA,000003.522,5830.4450,N,17012.6267,W,1,04,1.5,019.8,M,-008.9,M,,*5F

04/15/2007,00:00:05.427,\$GPGGA,000004.522,5830.4483,N,17012.6286,W,1,04,1.5,019.8,M,-008.9,M,,*59

FIELD	DATA	Examples	UNITS
1	SCS logged Date	04/15/2007	mm/dd/year
2	SCS logged Time GMT	00:00:05.427	h:mm:ss.sss
3	NMEA header	\$GPGGA	
4	GPS time at position GMT	000004.522	hhmmss.ss
5	Latitude	5830.4483	ddmm.mmmm
6	North (N) or South(S)	N	
7	Longitude	17012.6286	dddmm.mmmm
8	East (E) or West (W)	W	
9	GPS Quality: 1 = GPS2=DGPS	1	
10	Number of GPS Satellites Used	04	
11	HDOP (horizontal dilution of precision)	1.5	
12	Antenna height	019.8	meters
13	M for Meters	M	
14	Geoidal Height	-008.9	meters
15	M for Meters	M	
16	Differential reference station ID (no data in sample string)		
17	Checksum	*59	

PCode Aft GLL

Position data in NMEA GLL format from the Trimble Centurion receiver located in the Computer lab.

./pcode_aft_gll

Pcode-AFT-GLL_20070415-000000.Raw

04/15/2007,00:00:03.474,\$GPGLL,5830.4417,N,17012.6249,W,000002.522,A*25

04/15/2007,00:00:04.474,\$GPGLL,5830.4450,N,17012.6267,W,000003.522,A*2

04/15/2007,00:00:05.490,\$GPGLL,5830.4483,N,17012.6286,W,000004.522,A*2D

FIELD	DATA	Example	UNITS
1	SCS logged Date	04/15/2007	mm/dd/year
2	SCS logged Time GMT	00:00:05.490	hh:mm:ss.sss
3	NMEA header	\$GPGLL	
4	Latitude	5830.4483	ddmm.mmmm
5	North or South	N	
6	Longitude	17012.6286	dddmm.mmmm
7	East or West	W	
8	GMT of Position	000004.522	hhmmss.sss
9	Status of data (A=valid)	A	
10	Checksum	*2D	

PCode AFT VTG

Course and speed over ground in NMEA VTG format from the Trimble Centurion receiver located in the Computer lab.

./pcode_aft_vtg

Pcode-AFT-VTG_20070415-000000.Raw

04/15/2007,00:00:03.537,\$GPVTG,343.7,T,331.4,M,012.4,N,023.0,K*4E

04/15/2007,00:00:04.537,\$GPVTG,343.6,T,331.3,M,012.5,N,023.1,K*48

04/15/2007,00:00:05.537,\$GPVTG,343.6,T,331.3,M,012.4,N,023.0,K*48

FIELD	DATA	Example	UNITS
1	SCS logged Date	04/15/2007	mm/dd/year
2	SCS logged Time GMT	00:00:05.537	hh:mm:ss.sss
2	NMEA header	\$GPVTG	
3	Heading	343.6	Degrees
4	Degrees true (T)	T	
5	Heading	331.3	Degrees
6	Degrees magnetic	M	
7	Ship Speed	012.4	knots
8	N=Knots	N	
9	Ship Speed	023.0	km/hr
10	K=KM per hour	K	
11	Check sum	*48	

PCode AFT ZDA

Time and date data in the NMEA ZDA format. Data retrieved from the Trimble Centurion receiver located in the Computer lab.

./pcode_aft_zda

Pcode-AFT-ZDA_20070415-000000.Raw

04/15/2007,00:00:03.224,\$GPZDA,000003.00,15,04,2007,00,00,*4C

04/15/2007,00:00:04.224,\$GPZDA,000004.00,15,04,2007,00,00,*4B

04/15/2007,00:00:05.224,\$GPZDA,000005.00,15,04,2007,00,00,*4A

FIELD	DATA	Example	UNITS
1	SCS logged Date	04/15/2007	mm/dd/year
2	SCS logged Time GMT	00:00:05.537	hh:mm:ss.sss
2	NMEA header	\$GPZDA	
3	Time UTC	000005.00	hhmmss.sss
4	Day	15	DD
5	Month	04	MM
6	Year	2007	Year
7	??	00	??
8	??	00	??
9	Checksum	*4A	

PCode Bridge

PCode Bridge GGA

Position data in NMEA GGA format from the Trimble GPS receiver located on the bridge.

./pcode_bridge_gga

PCode-Bridge-GGA_20070415-000000.Raw

04/15/2007,00:00:03.037,\$GPGGA,000002.00,5830.469,N,17012.644,W,1,04,2.666,32.15,M,8.930,M,,*4D

04/15/2007,00:00:05.037,\$GPGGA,000004.00,5830.476,N,17012.648,W,1,04,2.667,31.82,M,8.930,M,,*45

04/15/2007,00:00:07.052,\$GPGGA,000006.00,5830.482,N,17012.651,W,1,04,2.668,31.55,M,8.930,M,,*41

FIELD	DATA	Example	UNITS
1	SCS logged Date	04/15/2007	mm/dd/year
2	SCS logged Time GMT	00:00:07.052	hh:mm:ss.sss
3	NMEA header	\$GPGGA	
4	GPS time at position GMT	000006.00	hhmmss.ss
5	Latitude	5830.482	ddmm.mmm
6	North (N) or South(S)	N	
7	Longitude	17012.651	dddmm.mmm
8	East (E) or West (W)	W	
9	GPS Quality: 1 = GPS2=DGPS	1	
10	Number of GPS Satellites Used	04	
11	HDOP (horizontal dilution of precision)	2.668	
12	Antenna height	31.55	meters
13	M for Meters	M	
14	Geoidal Height	8.930	meters
15	M for Meters	M	
16	Differential reference station ID (no data in sample string)		
17	Checksum	*41	

PCode Bridge GLL

Position data in NMEA GLL format from the Trimble GPS receiver located on the bridge.

./pcode_bridge_gll

Pcode-Bridge-GLL_20070415-000000.Raw

04/15/2007,00:00:03.099,\$GPGLL,5830.469,N,17012.644,W,000002.00,A*12

04/15/2007,00:00:05.099,\$GPGLL,5830.476,N,17012.648,W,000004.00,A*16

04/15/2007,00:00:07.099,\$GPGLL,5830.482,N,17012.651,W,000006.00,A*17

FIELD	DATA	Example	UNITS
1	SCS logged Date	04/15/2007	mm/dd/year
2	SCS logged Time GMT	00:00:07.099	hh:mm:ss.sss
3	NMEA header	\$GPGLL	
4	Latitude	5830.482	ddmm.mmm
5	North or South	N	
6	Longitude	17012.651	dddmm.mmm
7	East or West	W	
8	GMT of Position	000006.00	hhmmss.ss
9	Status of data (A=valid)	A	
10	Checksum	*17	

PCode Bridge VTG

Course and speed over ground data in NMEA VTG format from the Trimble GPS receiver located on the bridge.

./pcode_bridge_vtg

Pcode-Bridge-VTG_20070415-000000.Raw

04/15/2007,00:00:03.162,\$GPVTG,343.9,T,333.8,M,12.46,N,23.08,K*40

04/15/2007,00:00:05.162,\$GPVTG,343.8,T,333.8,M,12.49,N,23.12,K*45

04/15/2007,00:00:07.146,\$GPVTG,343.9,T,333.8,M,12.48,N,23.11,K*46

FIELD	DATA	Example	UNITS
1	SCS logged Date	04/15/2007	mm/dd/year
2	SCS logged Time GMT	00:00:07.146	hh:mm:ss.sss
2	NMEA header	\$GPVTG	
3	Heading	343.9	Degrees
4	Degrees true (T)	T	
5	Heading	333.8	Degrees
6	Degrees magnetic	M	
7	Ship Speed	12.48	knots
8	N=Knots	N	
9	Ship Speed	23.11	km/hr
10	K=KM per hour	K	
11	Check sum	*46	

Glonass

Glonass GGA

Position data in NMEA GGA format from the GLONASS GPS receiver.

./glonass_gga

Glonass-GGA_20070415-000000.Raw

04/15/2007,00:00:02.412,\$GPGGA,000002.00,5830.472078,N,17012.636881,W,1,09,0.9,22.999,M,9.46,M,,*49

04/15/2007,00:00:03.396,\$GPGGA,000003.00,5830.475412,N,17012.638716,W,1,09,0.9,23.000,M,9.46,M,,*40

04/15/2007,00:00:04.412,\$GPGGA,000004.00,5830.478732,N,17012.640527,W,1,09,0.9,22.932,M,9.46,M,,*4D

FIELD	DATA	Example	UNITS
1	SCS logged Date	04/15/2007	mm/dd/year
2	SCS logged Time GMT	00:00:04.412	hh:mm:ss.sss
3	NMEA header	\$GPGGA	
4	GPS time at position GMT	000004.00	hhmmss.ss
5	Latitude	5830.478732	ddmm.mmmmmm
6	North (N) or South(S)	N	
7	Longitude	17012.640527	dddmm.mmmmmm
8	East (E) or West (W)	W	
9	GPS Quality: 1 = GPS2=DGPS	1	
10	Number of GPS Satellites Used	09	
11	HDOP (horizontal dilution of precision)	0.9	
12	Antenna height	22.932	meters
13	M for Meters	M	
14	Geoidal Height	9.46	meters
15	M for Meters	M	
16	Differential reference station ID (no data in sample string)		
17	Checksum	*4D	

Glassnos GLL

Position data in NMEA GLL format from the GLONASS GPS receiver.

./glassnos_gll

Glomass-GLL_20070415-000000.Raw

04/15/2007,00:00:03.240,\$GPGLL,5830.475412,N,17012.638716,W,000003.00,A*12

04/15/2007,00:00:04.255,\$GPGLL,5830.478732,N,17012.640527,W,000004.00,A*16

04/15/2007,00:00:05.255,\$GPGLL,5830.482216,N,17012.642424,W,000005.00,A*11

FIELD	DATA	Example	UNITS
1	SCS logged Date	04/15/2007	mm/dd/year
2	SCS logged Time GMT	00:00:05.255	hh:mm:ss.sss
3	NMEA header	\$GPGLL	
4	Latitude	5830.482216	ddmm.mmmmmm
5	North or South	N	
6	Longitude	17012.642424	dddmm.mmmmmm
7	East or West	W	
8	GMT of Position	000005.00	hhmmss.ss
9	Status of data (A=valid)	A	
10	Checksum	*74	

Gyro

Gyro Heading

Heading data in NMEA HDT format from the Sperry gyrocompass.

./gyro

Gyro_20070415-000000.Raw

04/15/2007,00:00:01.912,\$HEHDT,346.647,T*2B

04/15/2007,00:00:03.912,\$HEHDT,346.713,T*2B

04/15/2007,00:00:05.927,\$HEHDT,346.735,T*2F

FIELD	DATA	Example	UNITS
1	SCS logged Date	04/15/2007	mm/dd/year
2	SCS logged Time GMT	00:00:05.927	hh:mm:ss.sss
3	NMEA header	\$HEHDT	
4	Heading	346.735	degrees
5	True (T) or Magnetic (M)	T	
6	Check sum	*2F	

Waypoints

IBS Waypoints

Waypoints from the Healy's Integrated Bridge System (IBS).

./ibs_waypoints

IBS-WayPoints_20070415-000000.Raw

04/15/2007,00:00:03.193,\$NVWPL,6152.68,N,17402.58,W,62*51

04/15/2007,00:00:04.193,\$NVWPL,6156.58,N,17422.68,W,63*56

04/15/2007,00:00:05.193,\$NVWPL,6202.16,N,17439.96,W,64*52

FIELD	DATA	Example	UNITS
1	SCS logged Date	04/15/2007	mm/dd/year
2	SCS logged Time GMT	00:00:05.193	hh:mm:ss.sss
3	NMEA header	\$NVWPL	
4	Latitude	6202.16	ddmm.mm
5	North or South	N	
6	Longitude	17439.96	dddmm.mm
7	East or West	W	
8	Waypoint number	64	
9	Checksum	*52	

Speed Log

Sperry Sped Log

Ground/water speed data from the Sperry Speed Log.

./sperry_speedlog

Sperry-Speedlog_20070415-000000.Raw

04/15/2007,00:00:02.755,\$VDVBW,12.32,0.85,A,12.43,0.66,A*5A

04/15/2007,00:00:03.271,\$VDVBW,12.33,0.80,A,12.44,0.66,A*59

04/15/2007,00:00:03.771,\$VDVBW,12.34,0.78,A,12.45,0.68,A*56

FIELD	DATA	Example	UNITS
1	SCS logged Date	04/15/2007	mm/dd/year
2	SCS logged Time GMT	00:00:03.771	hh:mm:ss.sss
2	NMEA header	\$VDVBW	
3	Fore-aft Water Speed - = astern	12.34	knots
4	Port-Stbd Water Speed - = port	0.78	knots
5	A= Data Valid V=Invalid	A	
6	Fore-aft Bottom Speed - = astern	12.45	knots
7	Port-Stbd Bottom Speed - = port	0.68	knots
8	A= Data Valid V=Invalid	A	
9	Checksum	*56	

Sound Velocimeter

SV2000

Sound Velocity data from the SV2000 sound velocimeter.

./sv2000

Sound-Velocimeter_20070415-000000.Raw

NO DATA

./Raw

The following section are in the Raw data directory on the DVD.

75 KHz ADCP data

./adcp75

The shipboard ADCP system measures currents in the depth range from about 30 to 300 m -- in good weather. In bad weather or in ice, the range is less, and sometimes no valid measurements are made. ADCP data collection occurs on the Healy for the benefit of the scientists on individual cruises and for the long-term goal of building a climatology of current structure in the Ocean.

The ADCP data set collected during this cruise are placed in the directory ./Raw/adcp75. The archive consists of a single file for each day of data collection. The files are named by the cruise HLY0701, a three place number of the sequence in the files, then an extra “_000000”, and then an extent for the kind of data in the file. An example of the files for one set is:

FILE NAME	FILE EXTENSION	DEFINITION
<i>HLY0701022_000000</i>	<i>.ENR</i>	Raw Binary ADCP Data
<i>HLY0701022_000000</i>	<i>.ENS</i>	Binary Adcp Data
<i>HLY0701022_000000</i>	<i>.ENX</i>	Binary Ensemble Data
<i>HLY0701022_000000</i>	<i>.STA</i>	short term average
<i>HLY0701022_000000</i>	<i>.LTA</i>	long term average
<i>HLY0701022_000000</i>	<i>.NIR</i>	Raw NMEA ASCII
<i>HLY0701022_000000</i>	<i>.N2R</i>	Raw NMEA ASCII
<i>HLY0701022_000000</i>	<i>.NMS</i>	Averaged Nav Data

150 Khz ADCP data

There was no adcp 150 run during HLY0701

./adcp150

KNUDSEN 320B/R

The Knudsen 320B/R depth sounder can record depth in both 3.5 and 12 kHz mode. The Healy records the 3.5 kHz data (Sub Bottom Profile) under way. This data is saved in all of the formats that the Knudsen can record data in. These files are in both ASCII and BINARY format (see the table below). This data is also saved as depth in Datalog/Knudsen.

./knudsenraw

FILENAME	FORMAT	DEFINITION
<i>2007_102_0005_004.keb</i>	Binary	Knudsen Playback File
<i>2007_102_0005_008.kea</i>	Ascii	Log of depth, settings and environmental data
<i>2007_102_0005_HF_001.sgy</i>	Binary	SEG-Y extended Seismic format

POSMV

The files saved in the directory *pos_mv* are all ones that the *posmvnav* computer logged from various navigation devices and devices related to the Seabeam system. The files use the naming convention of the name of the cruise, the device and an extent that has the year and Day of Year day. An example for the ADU5 GPS receiver on day 105 in 2007 would be: HLY0701-adu5.y2007d105. The files are ASCII

./pos_mv

HLY0701-adu5.y2007d105 – “Ashtech” GPS

HLY0701-aggps.y2007d105 – Differential GPS

HLY0701-ftsgauss.y2007d105 – TSG ASCII data

HLY0701-ftsgaussraw.y2007d105 – Raw TSG in HEX with a time stamp

HLY0701-par.y2007d105 – Raw PAR sensor data

HLY0701-posatt.y2007d105 – POSNV Attitude data

HLY0701-posnav.y2007d105 – POSMV Nav data

HLY0701-posreform2sb.y2007d105 – Reformatted POSMV for Seabeam

HLY0701-sbsv.y2007d105 – Surface Sound Velocity

POSMV Events

The events directory in the *pos_mv* directory has event files from various system showing start and stop times and various events in the recording and setup history of the device.

/pos_mv/events**Seabeam**

The raw Seabeam 2112 binary files are in this directory. The naming convention uses the year, month, Day of Year day, and the start hour and minute in it. For year 2007 on day 110 starting at 11:12 the

name would be sb20071101112.mb41. mb41 is the multibeam format number for the Seabeam 2112 that the Healy uses. This can best be accessed and used by using the MB-System software.

./Seabeam

sb20071091600.mb41

Thermosalinograph

Thermosalinograph AFT

Not used for HLY0701

./tsg_aft

Thermosalinograph Forward

The Forward Thermosalinograph data is written here in the binary format that SeaBird puts out. There are 2 files for each time period. The files use the name of the cruise and a sequence number in the recording for the cruise. See the SeaBird software Seacat for further processing.

./tsg_fwd

HLY07TSGFwd0701-2.CON

HLY07TSGFwd0701-2.hex

CTD

Data for the each CTD cast are contained here. These files are in SeaBird software's format. Each cast is in a separately numbered subdirectory.

./ctd

FILENAME	FORMAT	DEFINITION
<i>021.BL</i>	ASCII	Bottle firing information
<i>021.CON</i>	ASCII	The configuration file for the cast
<i>021.HDR</i>	ASCII	Header information for the cast
<i>021.btl</i>	ASCII	Averaged Bottle firing information
<i>021.cnv</i>	ASCII	The data
<i>021.dat</i>	Binary	The data
<i>021.jpg</i>	Binary	Plotted JPEG image of the cast
<i>021.ros</i>	ASCII	Data from when bottles fire
<i>021avg.cnv</i>	ASCII	Meaned 1 meter down cast of the data

Expandable Bathythermograph (XBT)

No XBTs were taken on HLY0701. The file names use the probe type and the sequence number of the XBT in the series used for the cruise.

./xbt

FILENAME	EXTENSION	DEFINITION	PROGRAM REQUIRED to read the file
T5_00014.rdf	.RDF	Raw Data Format	Sippican Software
T5_00014.edf	.EDF	Exportable Data Format	Any text/spreadsheet

Oxygen Concentration Sensor

On Hly0701 an Oxygen Concentration Sensor was run underway in the Bio/Chem Lab. The data are in Excel files. These data are preliminary, the data are not yet quality controlled. There is also a directory (Opto_Raw) of the raw data in files for each day.

./Optode

Optode_corrected.xls

11-Apr-07 1:27:18 343.64
 11-Apr-07 1:27:48 347.23
 11-Apr-07 1:28:18 348.23

FIELD	DATA	Example	UNITS
1	Date	11-Apr-07	mm/dd/year
2	Time	1:27:18	
3	O2 Concentration	343.64	O2 conc (µmol/L)

./Images

Aloft Con Camera

This directory contains picture files, from the Aloft Con forward view, separated into sub-directories named by Day of Year (YYYYJJJ). The picture files are in JPEG format taken every 5 minutes. The file names have the year, Day of Year and time in them.

/AloftConCam

2007-106-2255.jpeg
 2007-106-2300.jpeg
 2007-106-2305.jpeg

Fan Tail Camera

This directory contains picture files, from the Fan Tail view from Aft Con, separated into sub-directories named by Day of Year (YYYYJJJ). The picture files are in JPEG format taken every 1 minute. The file names have the year, Day of Year and time in them.

/FantailCam

2007-115-221501.jpeg

2007-115-222001.jpeg

2007-115-222501.jpeg

Satellite Images

/Satellite_Image

This directory contains satellite imagery of two types in jpeg format. Each type of data is separated into sub-directories by Year, Month and Day (YYYYMMDD).

/hrpt

This is data a High-Resolution Picture Transmission (HRPT) from the Chinese FengYun-1 (FY-1) Meteorological Satellite. The files are in Jpeg format named using Year, Month, Day, Hour and Minute. There are several types of images for each time frame.

200704210752.noaa-14.1km_ir_ch5.jpeg

200704210752.noaa-14.1km_vis_ch1.jpeg

200704210752.noaa-14.1km_vis_ch2.jpeg

/dmisp

This data is from the Defense Meteorological Satellite Program (DMSP). The files are in Jpeg format named using Year, Month, Day, Hour and Minute. There are several types of images for each time frame.

200704210101.f-12.1km_vis.jpeg

200704210101.f-12.4km_ir.jpeg

200704210101.f-12.4km_vis.jpeg

APPENDIX:**Acquisition Problems and Events**

This table summarizes problems with acquisition noted during this cruise including instrument failures, data acquisition system failures and any other factor affecting this data set. Times are reported in GMT. You should look for more complete details for these events in the ELOG accounts.

Date	Time	Event
04/10/07	20:12	Start LDS logging for HLY0701
04/10/07	20:26	SCS data logging started
04/10/07	21:02	SeaBeam in Survey mode
04/10/07	21:09	start Bottom Knudsen 3.5 E/S recording
04/11/07	03:31	Science Uncontaminated Seawater energized
04/11/07	03:32	Forward TSG started
04/11/07	04:22	New SVP for SeaBeam
04/11/07	05:22	Differential GPS from Beacon to Source
04/11/07	05:40	SCS logging for PAR enabled and started
04/11/07	06:08	Knudsen was in Pinger Mode back to 3.5 Mode
04/11/07	16:39	Knudsen now on External trigger
04/11/07	22:00	ADCP 75 stopped for trigger tests
04/11/07	23:00	Knudsen data not coming into SCS
04/12/07	04:05	ADCP 75 getting POSMV PRDID and nav data
04/12/07	04:07	ADCP75 only getting GGA, PRDID and PASHR only from POSMV
04/12/07	04:17	ADCP 75 nav now using original configuration
04/12/07	05:20	ADCP75 GYRO input seems to have stopped in the last day or so
04/12/07	06:58	SCS has not seen any Knudsen data since 05:02
04/12/07	09:30	Flowmeter installed in Bio Chem Lab
04/12/07	11:41	GYRO restarted on the bridge
04/12/07	13:18	new SVP for SeaBeam
04/12/07	18:45	Knudsen data was logged to disk but the SCS realtime display didn't work since the Serial Output was set to ECHOTrack. Fixed
04/13/07	03:35	IBS heading changed from GYRO to ADU5 GPS
04/13/07	03:35	Change fluorescence voltage scale factor from 0-80ug/l to 0-30ug/l
04/13/07	04:30	TSG down to wire Turbidity
04/13/07	05:21	Turbidity scale factor changed

HLY0701 Data Synopsis

04/13/07	05:26	in SCS add to TSG fluorometer volts, turbidity volts, and turbidity NTU units
04/13/07	07:18	SCS started and stopped several times to start recording SCUFA and Flowmeter
04/13/07	10:02	New SVP for SeaBeam
04/13/07	18:21	ADCP 75 appears to have heading, pitch and roll going
04/13/07	21:25	Differential GPS from Satellite to Beacon
04/13/07	22:08	ADCP 75 down to add trigger amp input. Not work.
04/14/07	10:03	New SVP for SeaBeam
04/15/07	00:24	SCS stopped to intergrate PAR derived sensor calibration factor of 1656.266 reviously done in the sensor
04/15/07	01:01	New SVP for SeaBeam
04/15/07	01:52	New SVP for SeaBeam
04/16/07	01:00	Differential GPS seems to be not coming in
04/16/7	11:14	No data not being logged in SCS
04/16/07	16:14	Note that there is no trigger being sent to ICnoGYRO. This means no Knudsen or fish finder data is being recorded.
04/16/07	17:44	Trigger signal fixed to ICnoGYRO room. Knudsen and fish finder are operating again.
04/16/07	21:46	TSG changed turbidity scale factor in scusoft to 2.
04/16/07	21:49	TSG changed fluorometer scale factor from 5 to 6 in scusoft.
04/16/07	21:49	TSG changed turbidity factor from 1 to 2 in seasoft
04/16/07	16:43	chprt license on Terascan activated successfully
04/16/07	16:57	successful in getting fy1-d Terascan data
04/16/07	19:05	Ashtech restarted after lost connection
04/17/07	13:32	new SVP for SeaBeam
04/17/07	13:33	new 8mm tape in SeaBeam
04/18/07	11:13	new SVP for SeaBeam
04/18/07	21:35	Redid changes in Terascan and fy1-d back in schedule
04/19/07	09:26	SCS stop logging RMYoung Port Wind
04/19/07	09:57	SCS stopped
04/19/07	09:58	SCS restarted, Flowmeter now logging to tsg_flow
04/19/07	14:25	RMYoung Port Wind not recording from about 1000 to 1200
04/19/07	04:28	new SVP for SeaBeam
04/19/07	21:02	Winch data now sent to SCS
04/20/07	14:49	new SVP for SeaBeam

HLY0701 Data Synopsis

04/20/07	23:09	ADCP 75 some time ago stopped getting GYRO
04/21/07	00:20	reset AD Syncro Converter on bridge
04/21/07	10:15	new SVP for SeaBeam
04/21/07	15:01	new SVP for SeaBeam
04/21/07	22:05	Knudsen shut itself down at some earlier time
04/21/07	22:35	Knudsen up and recording again
04/22/07	01:30	new SVP for SeaBeam
04/22/07	02:35	Psmvnav stopped collecting data, due to lockup
04/22/07	02:46	Posmvnav restarted and collecting data
04/22/07	04:41	Knudsen put into pinger mode for coring
04/22/07	06:14	Knudsen back to 3.5 mode
04/22/07	08:35	Knudsen SCS alarm from 07:59 to 08:18 for no data due to ADCP trigger tests
04/22/07	09:50	Knudsen data lost again at 09:35 upped the gain and found bottom
04/22/07	11:16	new SVP for SeaBeam
04/22/07	11:53	Knudsen to Pinger mode for coring
04/22/07	11:54	Seabeam to idle to see pinger on Knudsen
04/22/07	12:23	SeaBeam collecting data again
04/22/07	13:17	Knudsen set back to 3.5 mode and collecting data
04/23/07	00:45	SeaBeam is not finding bottom it appears
04/23/07	01:01	SeaBeam nav did not get inserted from 4/22 02:35 to 4/22 -02:47. Fixed the SeaBeam file to correct this.
04/23/07	11:30	new SVP for SeaBeam
04/24/07	07:00	ADCP 75 GYRO locked up, reset with power cycle
04/24/07	11:51	new 8mm tape put in for SeaBeam
04/24/07	14:53	new SVP for SeaBeam
04/24/07	20:16	No SeaBeam or Knudsen bottoms to now from 16:45
04/24/07	21:02	Science uncontaminated seawater secured due to ice plug
04/24/07	22:30	Uncontaminated Seawater back on
04/25/07	03:03	TSG water not flowing again
04/25/07	04:14	TSG noted to be flowing again
04/25/07	14:30	TSG flow increased from 12 - 15
04/25/07	16:17	new SVP for SeaBeam
04/25/07	19:03	ADCP 75 trigger test again and fail

HLY0701 Data Synopsis

04/26/07	00:00	ADCP 75 trigger test. This caused Knudsen to stop about an hour. Trigger test did not work.
04/26/07	15:50	ADCP 75 trigger test, still not work
04/26/07	20:56	new SVP for SeaBeam
04/27/07	01:01	Differential GPS on beacon. Had been not acquiring data.
04/27/07	03:32	new SVP for SeaBeam
04/27/07	03:57	Knudsen to pinger mode for coring
04/27/07	05:17	Knudsen back for 3.5 mode and recording
04/27/07	10:05	new SVP for SeaBeam
04/28/07	00:12	Stopped Knudsen and shutdown
04/28/07	00:47	Restart Knudsen with upper unit (K20013)
04/28/07	01:00	ADCP 75 trigger tests
04/28/07	08:49	new SVP for SeaBeam
04/28/07	15:09	new SVP for SeaBeam
04/28/07	20:09	ADCP75 now running in trigger mode!
04/29/07	09:08	new SVP for SeaBeam
04/30/07	12:38	new SVP for SeaBeam
04/30/07	14:17	new SVP for SeaBeam
04/30/07	20:37	new SVP for SeaBeam
04/30/07	20:39	New 8mm tape #5 after cleaning tape drive
05/01/07	11:31	new SVP for SeaBeam
05/01/07	13:45	Knudsen to Pinger Mode for MultiCore
05/01/07	14:45	Knudsen back to 3.5 Mode
05/01/07	15:56	Knudsen to Pinger Mode for MultiCore
05/01/07	16:51	Knudsen back to 3.5 Mode
05/01/07	19:35	new SVP for SeaBeam
05/02/07	13:04	new SVP for SeaBeam
05/02/07	07:35	Knudsen to Pinger Mode for MultiCore
05/02/07	09:08	Knudsen back to 3.5 Mode
05/02/07	09:26	new SVP for SeaBeam
05/02/07	10:55	Knudsen to Pinger Mode for MultiCore
05/02/07	12:37	Knudsen back to 3.5 Mode
05/03/07	09:58	new SVP for SeaBeam
05/03/07	23:41	VMS lost heading Ashtech reset
05/04/07	00:59	ADCP75 back to internal trigger PMEL_BB_WBT_NXT.txt

HLY0701 Data Synopsis

05/04/07	01:04	ADCP75 gyro looks frozen
05/04/07	02:47	new SVP for SeaBeam
05/04/07	11:34	new SVP for SeaBeam
05/05/07	07:06	Note PAR is giving negative values (4/38 20:27)
05/05/07	13:44	new SVP for SeaBeam
05/06/07	16:27	new SVP for SeaBeam
05/07/07	06:38	new SVP for SeaBeam
05/08/07	10:25	new SVP for SeaBeam
05/08/07	23:08	new 8mm tape #6 for SeaBeam
05/09/07	09:22	new SVP for SeaBeam
05/09/07	22:34	Random restarts of SCS until 22:53
05/10/07	10:22	new SVP for SeaBeam
05/10/07	17:49	new SVP for SeaBeam
05/11/07	00:03	POSMV went into standby and reset? 5/10 23:15 or so
05/11/07	02:46	POSMV Attitude now good again
05/11/07	06:44	new SVP for SeaBeam
05/11/07	17:11	new SVP for SeaBeam
05/11/07	23:35	new SVP for SeaBeam
05/12/07	14:11	TSG and Science Seawater secured
05/12/07	14:18	ADCP75 stop recording
05/12/07	14:19	Knudsen stop recording data
05/12/07	14:19	Seabeam stop recording data
05/12/07	15:05	Snap server synchronization stopped.
05/12/07	15:10	Secured one minute event file, SCS Message
05/12/07	16:20	LDS logging stopped

Calculations

Some of the data values were calculated. The description of these data are below.

TSG

Raw TSG data is stored as a 20 byte (character) long hex string. Please also see the Appendix section SBE 21 SEACAT Thermosalinograph Data Output Formats below.

Before 04/13/07

ftsgauss 2007:103:04:30:08.3076 111665C80AE8E00621 1443.37 0.07 -0.36 2.67 31.82

<i>Bytes</i>	<i>Data</i>	<i>Hex Data Example</i>
1-4	Intake Temperature	1116
5-8	Conductivity	65C8
9-14	Remote Temperature	0AE8E0
15-18	Fluorometer voltage	0621

After 04/13/07

ftsgauss 2007:103:04:33:33.8985 110E65C10AEE1D61F000 1443.76 0.06 -0.27 2.67 31.82

<i>Bytes</i>	<i>Data</i>	<i>Hex Data Example</i>
1-4	Intake Temperature	110E
5-8	Conductivity	65C1
9-14	Remote Temperature	0AEE1D
15-17	Fluorometer voltage	61F
18-20	Turbidity voltage	000

The coefficients for temperature, conductivity, fluorometer and turbidity sensors can be found in the calibrations sheets below in the Appendix.

Calculating Temperature – ITS-90

T = decimal equivalent of bytes 1-4
 Temperature Frequency: $f = T/19 + 2100$
 Temperature = $1/\{g + h[\ln(f_0/f)] + i[\ln^2(f_0/f)] + j[\ln^3(f_0/f)]\} - 273.15$ (°C)

Calculating Conductivity – ITS-90

HLY0701 Data Synopsis

C = decimal equivalent of bytes 5-8

Conductivity Frequency $f = \sqrt{C \cdot 2100 + 6250000}$

Conductivity = $(g + hf^2 + if^3 + jf^4) / [10(1 + \delta t + \epsilon p)]$
(siemens/meter)

t = temperature ($^{\circ}\text{C}$); p = pressure (decibars); $\delta = \text{Ctcor}$; $\epsilon = \text{CPcor}$

Calculating Fluorometry Voltage

f = decimal equivalent of bytes 15-17

Fluorometry Voltage = $f/819$

Calculating Transmittance

$V_{\text{dark}} = 0.058 \text{ V}$

$V_{\text{ref}} = 4.765 \text{ V}$

t = decimal equivalent of bytes 18 - 20

Transmissometer Voltage (V_{signal}) = $t/819$

% Transmittance = $(V_{\text{signal}} - V_{\text{dark}}) / (V_{\text{ref}} - V_{\text{dark}})$

PAR

raw data = mV

calibration scale = $6.08 \text{ V} / (\mu\text{Einstiens}/\text{cm}^2\text{sec})$

offset (V_{dark}) = 0.3 mV

$(\text{raw mV} - V_{\text{dark}}) / \text{scale} \times 10^4 \text{ cm}^2/\text{m}^2 \times 10^{-3} \text{ V/mV} = \mu\text{Einstiens}/\text{m}^2\text{sec}$

or

$(\text{data mV} - 0.3 \text{ mV}) \times 1.65 (\mu\text{Einstiens}/\text{m}^2\text{sec})/\text{mV} = \mu\text{Einstiens}/\text{m}^2\text{sec}$

Sensors and Calibrations***HLY0701 Shipboard Sensors***

Sensor	Description	Serial #	Last Calibration Date	Status
Meteorology & Radiometers				
Port Anemometer	RM Young 09101	L001	02/06/07	Collected
Stbd Anemometer	RM Young 09101	L003	03/07/07	Collected
Barometer	RM Young 61201	BP01643	03/07	Collected
Air Temp/Rel. Hum.	RM Young 41382VC	109652	03/07	Collected
Helo shack PAR	BSI QSR-2200	20270	01/09/07	Collected
Underway Ocean				
TSG	SeaBird SBE21	1864	01/23/07	Collected
Remote Sea Temp	SeaBird SBE3S	4063	01/24/07	Collected
Fluorometer	Turner SCUFA	0584	01/22/07	Collected
Sonars				
Knudsen- subbottom	320 B/R	K2K-00-0013	N/A	Collected
ADCP 150 kHz	Broad Band (BB150)	80	N/A	Collected
ADCP 75 kHz	Ocean Surveyor	172	N/A	Collected
Multibeam	Seabeam 2112	?	N/A	Collected
Speed log	Sperry	?	N/A	Collected
Navigation				
P-Code GPS (aft)	Trimble Centurion	0220035469	N/A	Collected
Attitude GPS	Ashtech ADU5	AD520033513	N/A	Collected
DGPS	Trimble AGGPS-AG132	0224016199	N/A	Collected
POSMV	Model- MV V4	2306	N/A	Collected
P-Code GPS (fwd)	?	?	N/A	Collected
Glionass	?	?	N/A	Collected
GYRO 1	Sperry MK25	?	N/A	Collected
GYRO 2	Sperry MK25	?	N/A	Collected

HLY0701- CTD Sensors

Sensor	Comments	Serial #	Last service/ Calibration Date	Status
CTD fish	SBE 911plus	638	05-Dec-06	Collected
Pressure Sensor #1	Digiquartz with TC	83009	05-Dec-06	Collected
Temperature #1	SBE3- Primary	2841	24-Jan-07	Collected
Temperature #2	SBE3- Secondary	2824	25-Jan-07	Collected
Conductivity #1	SBE4- Primary	2545	19-Jan-07	Collected
Conductivity #2	SBE4- Secondary	2619	19-Jan-07	Collected
Dissolved Oxygen #1	SBE-43	0458	10-Feb-07	Collected
PAR Sensor	BSI QSP2300	70115	09-Jan-07	Collected
Fluorometer #1	Chelsea Mk III Aquatracka	088234	06-Mar-07	Collected
Transmissometer	Wetlabs CST-397DR	CST-390DR	27-Feb-07	Collected
Pump	SBE5 Primary	3115	27-Jan-07	
Pump	SBE5 Secondary	3116	27-Jan-07	
Carousel Water Sampler	SBE-32	0348	?	
Deck Unit	SBE 11-Plus V2	0416	?	
Altimeter	PSA916D	1062	Jan 07	Collected

Calibrations

The following pages are replicas of current calibration sheets for the sensors used during this cruise.

Turner SCUFA Fluorometer

serial # 0584 page 1- APP. NOTE NO. 63- www.seabird.com

USE PEN ONLY

Reference TD130059 Scufa (TM) Test Procedure						
Electrical test						
S/N:	0584					
Date:	11/22/07					
Initial:	H3					
P/N	2000-006	2000-007	2000-008	2000-005	2000-010	Range
Vin						12.5V
Power						12.2 +/- 0.2V
"+5.5V"						5.5 +/- 0.3V
"3.3V"						3.3V +/- 0.1V
Vcc						3.3V +/- 0.1V
Va+						5 +/- 0.1V
Va-						"-5 +/- 0.2V"
U19, offset	-1.5					<15 mV
U29, offset	N/A	0.3			N/A	<15 mV
Signal offset	8.3					< +/- 50
Turb. Offset	N/A	2.8			N/A	< +/- 50
Current cons. Power ON	40					< 60 mA
Over-V threshold	15.3					15-15.5 V
Signal offset noise	1.8 (10 kHz)					< 20 mV p-p
Turb. Offset noise	N/A	10			N/A	< 20 mV p-p
Temp. Readout check	11.98 / 11.9					Ambient +/- 1°C
Unit Configuration, Table #1						
Turbidity	No.	Yes	Yes.	No.		
Temp. Compensation	Yes.	Yes	Yes.	No.		
Internal Data Logger	Yes.	Yes	Yes.	No.		
Calibration						
	Blank %	Range	Standard %	Range		
CHL	0.016 (100)	0-0.03	1.67	2.2-4.5		
TRB	0.015	0-0.03	1.19	43-70		
RWT		0-0.08		7.0-15.0		
TRB		0-0.05		20.5-70.0		
PC		0-0.03		0.5-1.2		
TRB						
FLU		0-0.05		2.0-10.0		
TRB		0-0.05		1.0-6.0		
Internal Data Logger Test IDL: ON or OFF (Circle one)						
IDL Tested OK: <input type="checkbox"/>						
Analog output calibration						
Analog Out 1	80	619 mV				(1)
Analog Out 2	25.7	2.4 V				(1)
Pressure test & Burn In						
Date	11/22/07					
Initial	H3					
Pressure	ST #12	ST #15	ST #20	ST #23		
	1000	1000	1000	1000		
Pre test weight	820.7	820.8				
After test weight	821.1					
Difference						< 0.5 gram
1) NOTES: Analog out: 1) Rhod and TRB: 2.5 +/- 0.1						
2) CHL: 0.625 +/- 0.05V						
3) FLU: 0.250 +/- 0.05V						
4) Others: Consult Product Development						

USE PEN ONLY

Burn In Test					
Start			Finish		
Date:	01/22	Date:	01/24		
Time:	1500	Time:	0830		
Initial:	WJ	Initial:	WJ		
Check / configuration test					
Configuration	2000-006	2000-007	2000-008	2000-005	2000-010
Date:		01/24			
Time:		0830			
Initial:		WJ			
Fluorescence (Black Rod)		0.006			
Turbidity (Black Rod)	N/A	0.010		N/A	
Fluorescence (Solid Std)		(9.12)			
Turbidity (Solid Std)	N/A	(94.95)		N/A	
Sig. Pre-amp. Out		(-6)			<+/-50
Turb. Pre-amp. Out	N/A	(-1)		N/A	<+/-50
Analog Out 1		(55.7)			(1)
Analog Out 2		(2.28)			(1)
IDL	ON	ON	ON	OFF	
Temp. Comp.	ON	ON	ON	OFF	
Temp. Readout check		26.5 / 19.5			Ambient +/- 1°C
FINAL INSTRUMENT CONFIGURATION (FOR CUSTOM ORDERS ONLY)					
Refer to 2000-010 Configuration Instructions (TD130063)					
Shop Order #:	IDL	Temp Comp	Turbidity	Date:	
2000-010 07	ON	ON	ON	Initial (1): WJ Initial (2):	

SCUFA TEST STATUS

INIT: WJ

- 1. S/N 0584 MODEL # 2000-007 S/O # 5356
- 2. S/N _____ MODEL # _____ S/O # _____
- 3. S/N _____ MODEL # _____ S/O # _____
- 4. S/N _____ MODEL # _____ S/O # _____
- 5. S/N _____ MODEL # _____ S/O # _____

BURN-IN:
 DATE IN 01/22/07 TIME 1500
 DATE OUT 01/24/07 TIME 0830

WEIGHT: (TEST LOG)

POST BURN-IN: (TEST LOG)

LABEL:

BOX:

COMMENTS:

Seabird SBE21 Thermosalinograph Calibration

Serial number 1864 Conductivity Calibration

SEA-BIRD ELECTRONICS, INC.

1808 136th Place N.E., Bellevue, Washington, 98005 USA

Phone: (425) 643 - 9866 Fax (425) 643 - 9954 Email: seabird@seabird.com

SENSOR SERIAL NUMBER: 1864
CALIBRATION DATE: 17-Feb-07

SBE21 CONDUCTIVITY CALIBRATION DATA
PSS 1978: C(35,15,0) = 4.2914 Seimens/meter

GHIJ COEFFICIENTS

g = -4.01848022e+000
h = 4.78130246e-001
i = 1.73756277e-003
j = -5.35324252e-005
CPcor = -9.5700e-008 (nominal)
CTcor = 3.2500e-006 (nominal)

ABCDM COEFFICIENTS

a = 5.51772628e-002
b = 4.20577678e-001
c = -4.01119247e+000
d = -1.84582181e-004
m = 2.1
CPcor = -9.5700e-008 (nominal)

BATH TEMP (ITS-90)	BATH SAL (PSU)	BATH COND (Siemens/m)	INST FREQ (kHz)	INST COND (Siemens/m)	RESIDUAL (Siemens/m)
22.0000	0.0000	0.00000	2.88532	0.00000	0.00000
1.0000	34.8699	2.98011	8.31725	2.98005	-0.00006
4.4999	34.8506	3.28763	8.68467	3.28769	0.00006
15.0000	34.8098	4.27090	9.76567	4.27093	0.00003
18.4999	34.8013	4.61658	10.11804	4.61660	0.00001
23.9999	34.7923	5.17544	10.66287	5.17538	-0.00006
29.0000	34.7872	5.69809	11.14827	5.69807	-0.00002
32.5000	34.7840	6.07099	11.48204	6.07103	0.00003

Conductivity = $(g + hf^2 + if^3 + jf^4) / 10(1 + \delta t + \epsilon p)$ Siemens/meter

Conductivity = $(af^m + bf^2 + c + dt) / [10(1 + \epsilon p)]$ Siemens/meter

t = temperature[°C]; p = pressure[decibars]; δ = CTcor; ϵ = CPcor;

Residual = (instrument conductivity - bath conductivity) using g, h, i, j coefficients

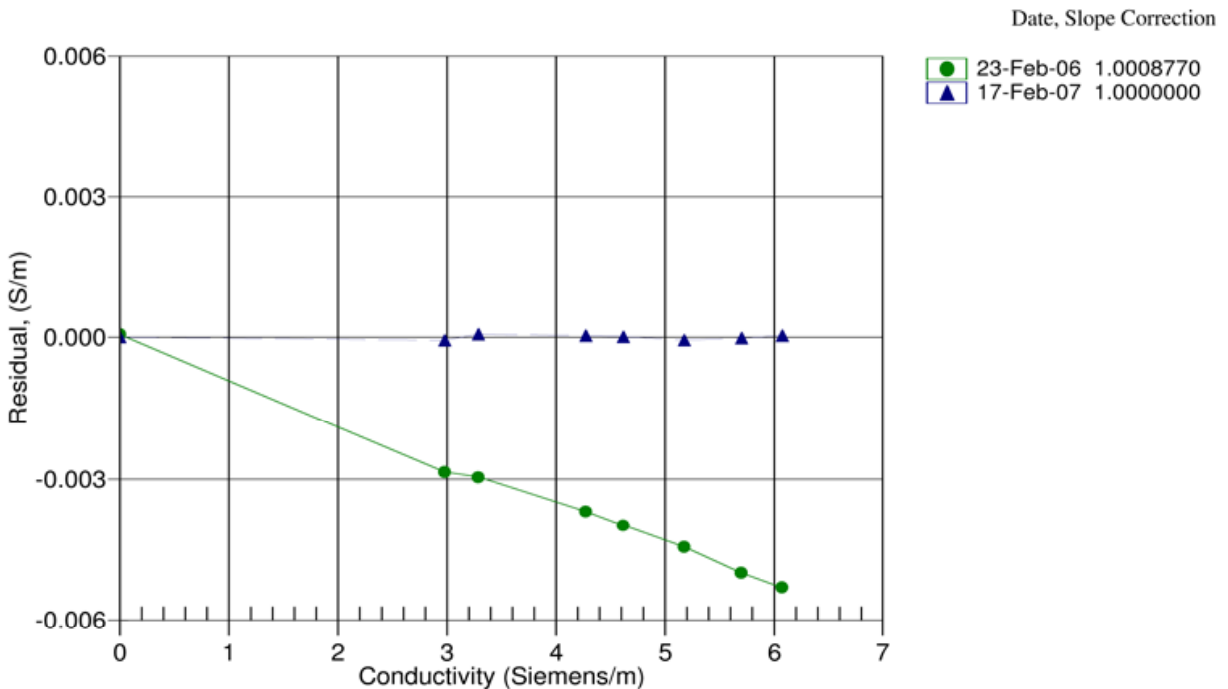

Serial number 1864 Temperature Calibration

SEA-BIRD ELECTRONICS, INC.

1808 136th Place N.E., Bellevue, Washington, 98005 USA

Phone: (425) 643 - 9866 Fax (425) 643 - 9954 Email: seabird@seabird.com

SENSOR SERIAL NUMBER: 1864
CALIBRATION DATE: 17-Feb-07

SBE21 TEMPERATURE CALIBRATION DATA
ITS-90 TEMPRATURE SCALE

ITS-90 COEFFICIENTS

g = 4.22123757e-003
h = 6.00091050e-004
i = 2.92943927e-006
j = -2.15310298e-006
f0 = 1000.0

ITS-68 COEFFICIENTS

a = 3.64763550e-003
b = 5.88588087e-004
c = 9.17857335e-006
d = -2.15270275e-006
f0 = 2621.105

BATH TEMP (ITS-90)	INSTRUMENT FREQ (Hz)	INST TEMP (ITS-90)	RESIDUAL (ITS-90)
1.0000	2621.105	1.0000	-0.00004
4.4999	2834.409	4.5000	0.00008
15.0000	3547.678	14.9999	-0.00007
18.4999	3811.076	18.4999	-0.00003
23.9999	4252.251	24.0000	0.00011
29.0000	4683.211	29.0000	-0.00005
32.5000	5002.409	32.5000	-0.00000

Temperature ITS-90 = $1/[g + h[\ln(f_0/f)] + i[\ln^2(f_0/f)] + j[\ln^3(f_0/f)]] - 273.15$ (°C)

Temperature ITS-68 = $1/[a + b[\ln(f_0/f)] + c[\ln^2(f_0/f)] + d[\ln^3(f_0/f)]] - 273.15$ (°C)

Following the recommendation of JPOTS: T_{68} is assumed to be $1.00024 * T_{90}$ (-2 to 35 °C)

Residual = instrument temperature - bath temperature

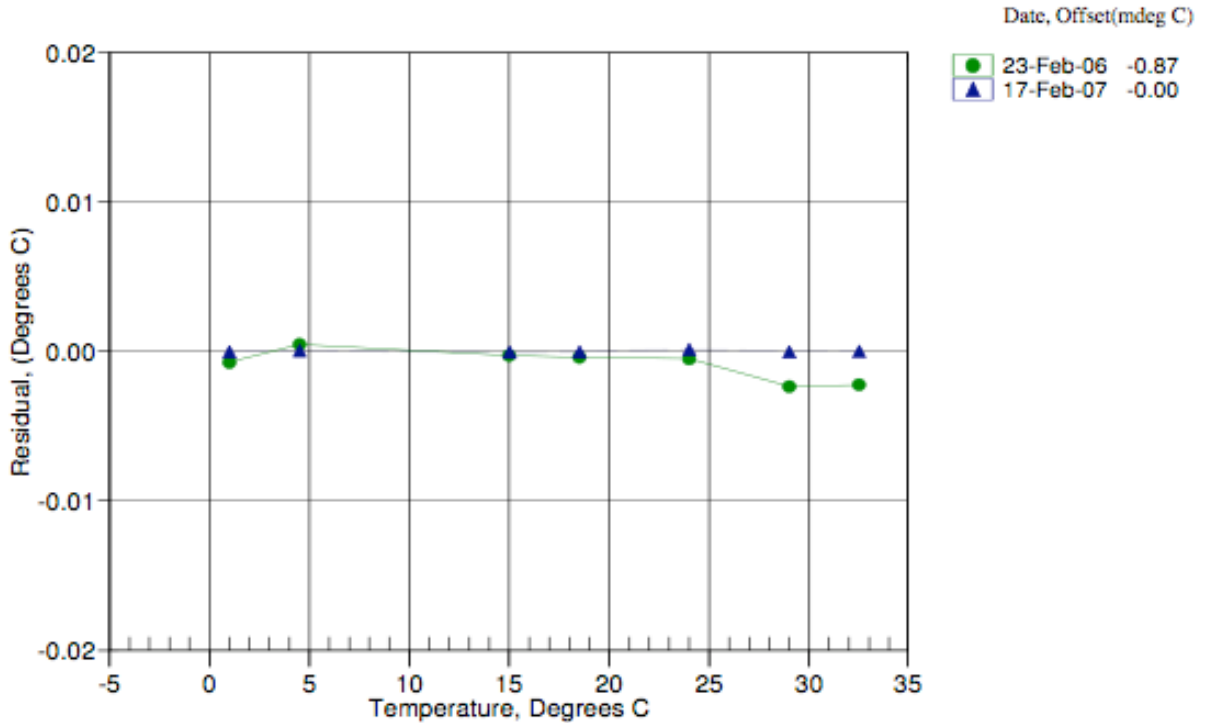

MET Sensors

PAR

Biospherical Instruments Inc.

CALIBRATION CERTIFICATE

Calibration Date 1/9/2007
 Model Number QSR-2200
 Serial Number 20270
 Operator TPC
 Standard Lamp F-863
 Probe Excitation Voltage Range: 6 to 18 VDC(+)
 Output Polarity: Positive

Probe Conditions at Calibration(in air):

Calibration Voltage: 6 VDC(+)
 Probe Current: 4.0 mA

Probe Output Voltage:

Probe Illuminated 95.87 mV
 Probe Dark 1.32 mV
 Probe Net Response 94.55 mV

Corrected Lamp Output:

Output In Air (same condition as calibration):

9.43E+15 quanta/cm²sec
0.01566 uE/cm²sec

Calibration Factor:

(To calculate irradiance, divide the net voltage reading in Volts by this value.)

Dry: 1.00E-17 V/(quanta/cm²sec)
6.04E+00 V/(uE/cm²sec)

Notes:

1. Annual calibration is recommended.
2. Calibration is performed using a Standard of Spectral Irradiance traceable to the National Institute of Standards and Technology (NIST).
3. The collector should be cleaned frequently with alcohol.
4. Calibration was performed with customer cable, when available.

R.M. Young Wind Bird, Starboard

**R. M. Young Wind bird Calibration Results
Model # 09101, S/N L003 (Starboard Windbird)**

As per Young Meteorological Instruments
Wind System Calibration Manual

Date: 07 Mar 07

Technician: ET1 Berringer / ETC Rodda

Wind speed torque: Passed

Maximum toque = 2.4 gm/cm

Test results:

CW	0.7
CCW	0.7

Wind direction torque: Passed

Maximum toque = 30 gm/cm

Test results:

CW	20 gm/cm
CCW	22 gm/cm

Wind speed signal:

Maximum % error = 1%

Test results: Passed

Actual RPM	Actual Wind Speed	Measured	% Error
200	1.90	1.9	0.21
500	4.76	4.8	0.84
1200	11.42	11.4	0.21
3600	34.27	34.3	0.08
5000	47.60	47.6	0.00

Note; Wind speed in knots = 0.00952 * shaft RPM

Wind direction signal:

Maximum error = +/- 2 degrees

Test results: Failed – off by 1 degree

Actual	Measured	Error
0	358	-2
30	27	3
60	58	2
90	88	2
120	118	2
150	149	1
180	178	2
210	207	3
240	238	2
270	268	2
300	297	3
330	327	3

R.M. Young Wind Bird Port

**R. M. Young Wind bird Calibration Results
Model # 09101, S/N L001 (Port Windbird)**

As per Young Meteorological Instruments
Wind System Calibration Manual

Date: 06 Feb 07

Technician: ET3 Daem / ET2 Davis

Wind speed torque: Passed

Maximum torque = 2.40 gm/cm

Test results:

CW .2 gm/cm
CCW .2 gm/cm

Wind direction torque: Passed

Maximum torque = 30 gm/cm

Test results:

CW 10gm/cm
CCW 10gm/cm

Wind speed signal: Passed

Maximum % error = 1%

Test results:

Actual RPM	Actual Wind Speed	Measured	% Error
200	1.90	1.9	0.21
500	4.76	4.8	0.84
1200	11.42	11.4	0.21
3600	34.27	34.3	0.08
5000	47.60	47.6	0.00

Note; Wind speed in knots = 0.00952 * shaft RPM

Wind direction signal: Passed

Maximum error = +/- 2 degrees

Test results:

Actual	Measured	Error
0	359	-1
30	29	1
60	59	1
90	90	0
120	120	0
150	150	0
180	180	0
210	210	0
240	240	0
270	269	1
300	298	2
330	330	0

CTD Sensors

Pump

Serial number 53115

SBE SEA-BIRD ELECTRONICS, INC.
1808 - 136th Place Northeast, Bellevue, Washington 98005 USA
Phone: (425) 643-9866 Fax: (425) 643-9954 www.seabird.com

Service	RMA Number	45437
Report		

Customer Information:

Company	Scripps Institute of Oceanography	Date	1/27/2007
Contact	Scott Hiller		
PO Number	TBD		

Serial Number	053115
Model Number	SBE 05T

Services Requested:

1. Evaluate/Repair Instrumentation.

Problems Found:

Services Performed:

1. Performed hydrostatic pressure test.
2. Performed internal inspection and O-ring replacement.
3. Replaced the pump impeller thrust washers.
4. Performed initial diagnostic evaluation.

Special Notes:



SEA-BIRD ELECTRONICS, INC.

1808 - 136th Place Northeast, Bellevue, Washington 98005 USA

Phone: (425) 643-9866 Fax: (425) 643-9954 www.seabird.com

Pressure Test Certificate

Customer Scripps Institute of Oceanography
Job Number 45437
Date 1/26/2007
Technician SF

Serial Number 053115

Low Pressure (PSI) 50 PSI

Time (Minutes) 15 Minutes

High Pressure (PSI) 10000 PSI

Time (Minutes) 30 Minutes

Pass

Fail

Comments

Replaced the main piston "O"-Rings

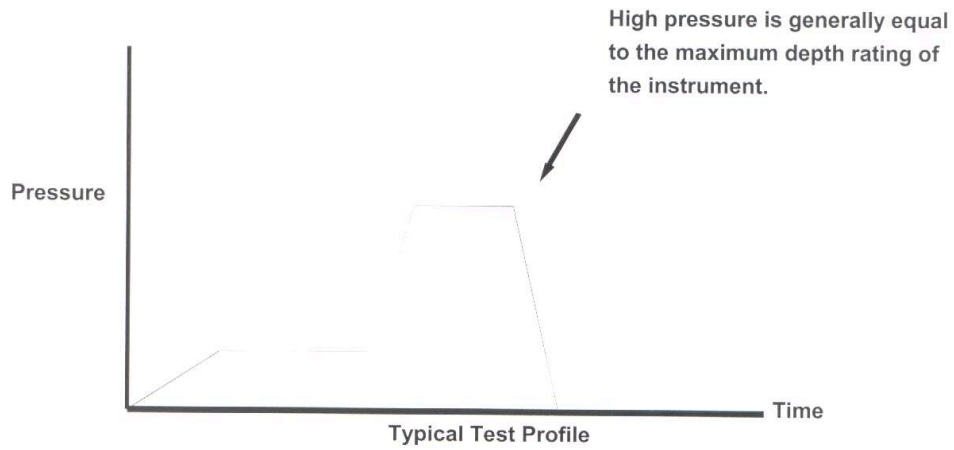

Temperature

Serial number 2824

SEA-BIRD ELECTRONICS, INC.
 1808 136th Place N.E., Bellevue, Washington, 98005 USA
 Phone: (425) 643 - 9866 Fax (425) 643 - 9954 Email: seabird@seabird.com

SENSOR SERIAL NUMBER: 2824
 CALIBRATION DATE: 25-Jan-07

SBE3 TEMPERATURE CALIBRATION DATA
 ITS-90 TEMPERATURE SCALE

ITS-90 COEFFICIENTS

g = 4.32220228e-003
 h = 6.37040873e-004
 i = 2.19538904e-005
 j = 2.06610336e-006
 f0 = 1000.0

ITS-68 COEFFICIENTS

a = 3.68121203e-003
 b = 5.98231489e-004
 c = 1.55358613e-005
 d = 2.06757922e-006
 f0 = 2828.715

BATH TEMP (ITS-90)	INSTRUMENT FREQ (Hz)	INST TEMP (ITS-90)	RESIDUAL (ITS-90)
-1.5000	2828.715	-1.5000	0.00002
1.0000	2992.266	1.0000	-0.00001
4.5000	3232.590	4.5000	-0.00003
8.0000	3486.502	8.0000	-0.00002
11.5000	3754.371	11.5000	0.00002
15.0000	4036.556	15.0001	0.00007
18.5000	4333.398	18.5000	0.00004
22.0000	4645.228	21.9999	-0.00012
25.5000	4972.410	25.5000	-0.00001
29.0000	5315.227	29.0000	0.00004
32.5000	5673.975	32.5000	-0.00001

Temperature ITS-90 = $1 / \{ g + h[\ln(f_0/f)] + i[\ln^2(f_0/f)] + j[\ln^3(f_0/f)] \} - 273.15$ (°C)

Temperature ITS-68 = $1 / \{ a + b[\ln(f_0/f)] + c[\ln^2(f_0/f)] + d[\ln^3(f_0/f)] \} - 273.15$ (°C)

Following the recommendation of JPOTS: T_{68} is assumed to be $1.00024 * T_{90}$ (-2 to 35 °C)

Residual = instrument temperature - bath temperature

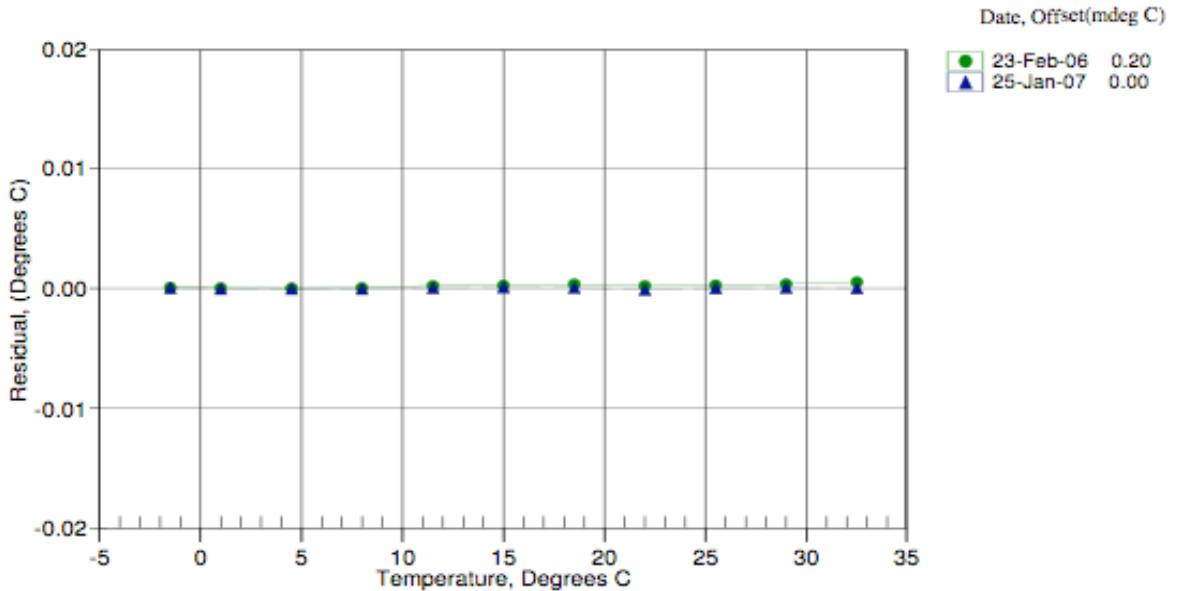

Serial number 2841

SEA-BIRD ELECTRONICS, INC.

1808 136th Place N.E., Bellevue, Washington, 98005 USA

Phone: (425) 643 - 9866 Fax (425) 643 - 9954 Email: seabird@seabird.com

SENSOR SERIAL NUMBER: 2841
CALIBRATION DATE: 24-Jan-07

SBE3 TEMPERATURE CALIBRATION DATA
ITS-90 TEMPERATURE SCALE

ITS-90 COEFFICIENTS

g = 4.36167363e-003
h = 6.43418980e-004
i = 2.26968381e-005
j = 2.09713034e-006
f0 = 1000.0

ITS-68 COEFFICIENTS

a = 3.68121210e-003
b = 6.01382162e-004
c = 1.58311859e-005
d = 2.09863963e-006
f0 = 2991.089

BATH TEMP (ITS-90)	INSTRUMENT FREQ (Hz)	INST TEMP (ITS-90)	RESIDUAL (ITS-90)
-1.5000	2991.089	-1.5000	0.00002
1.0000	3163.101	1.0000	0.00002
4.5000	3415.769	4.4999	-0.00007
8.0000	3682.633	8.0000	-0.00003
11.5000	3964.067	11.5000	0.00003
15.0000	4260.445	15.0001	0.00015
18.5000	4572.094	18.5000	-0.00003
22.0000	4899.396	21.9999	-0.00011
25.5000	5242.694	25.5000	-0.00001
29.0000	5602.291	29.0001	0.00005
32.5000	5978.486	32.5000	-0.00000

Temperature ITS-90 = $1 / \{ g + h[\ln(f_0/f)] + i[\ln^2(f_0/f)] + j[\ln^3(f_0/f)] \} - 273.15$ (°C)

Temperature ITS-68 = $1 / \{ a + b[\ln(f_0/f)] + c[\ln^2(f_0/f)] + d[\ln^3(f_0/f)] \} - 273.15$ (°C)

Following the recommendation of JPOTS: T_{08} is assumed to be $1.00024 * T_{90}$ (-2 to 35 °C)

Residual = instrument temperature - bath temperature

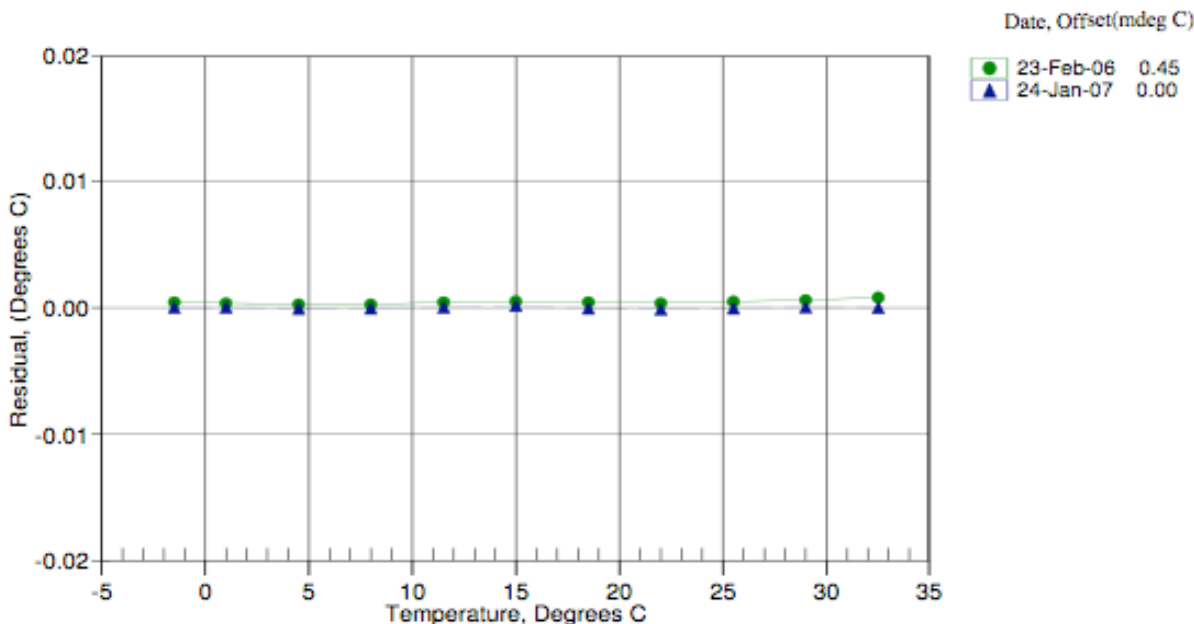

Conductivity

Serial number 2545

SEA-BIRD ELECTRONICS, INC.
 1808 136th Place N.E., Bellevue, Washington, 98005 USA
 Phone: (425) 643 - 9866 Fax (425) 643 - 9954 Email: seabird@seabird.com

SENSOR SERIAL NUMBER: 2545
 CALIBRATION DATE: 19-Jan-07

SBE4 CONDUCTIVITY CALIBRATION DATA
 PSS 1978: C(35,15,0) = 4.2914 Siemens/meter

GHJ COEFFICIENTS

g = -1.06802227e+001
 h = 1.64309266e+000
 i = -1.41782050e-003
 j = 2.03407248e-004
 CPcor = -9.5700e-008 (nominal)
 CTcor = 3.2500e-006 (nominal)

ABCDM COEFFICIENTS

a = 4.98318372e-006
 b = 1.63987312e+000
 c = -1.06749650e+001
 d = -8.74381693e-005
 m = 5.3
 CPcor = -9.5700e-008 (nominal)

BATH TEMP (ITS-90)	BATH SAL (PSU)	BATH COND (Siemens/m)	INST FREQ (kHz)	INST COND (Siemens/m)	RESIDUAL (Siemens/m)
0.0000	0.0000	0.00000	2.55131	0.00000	0.00000
-1.0001	34.9205	2.81218	4.86261	2.81215	-0.00003
1.0536	34.9202	2.98865	4.97191	2.98868	0.00003
14.9999	34.9203	4.28301	5.70940	4.28303	0.00002
18.4999	34.9199	4.63062	5.89163	4.63061	-0.00001
28.9999	34.9176	5.71703	6.42770	5.71699	-0.00003
32.4999	34.9094	6.09037	6.60180	6.09040	0.00002

Conductivity = $(g + hf^2 + if^3 + jf^4) / 10(1 + \delta t + \epsilon p)$ Siemens/meter

Conductivity = $(af^m + bf^2 + c + dt) / [10(1 + \epsilon p)]$ Siemens/meter

t = temperature[°C]; p = pressure[decibars]; δ = CTcor; ϵ = CPcor;

Residual = (instrument conductivity - bath conductivity) using g, h, i, j coefficients

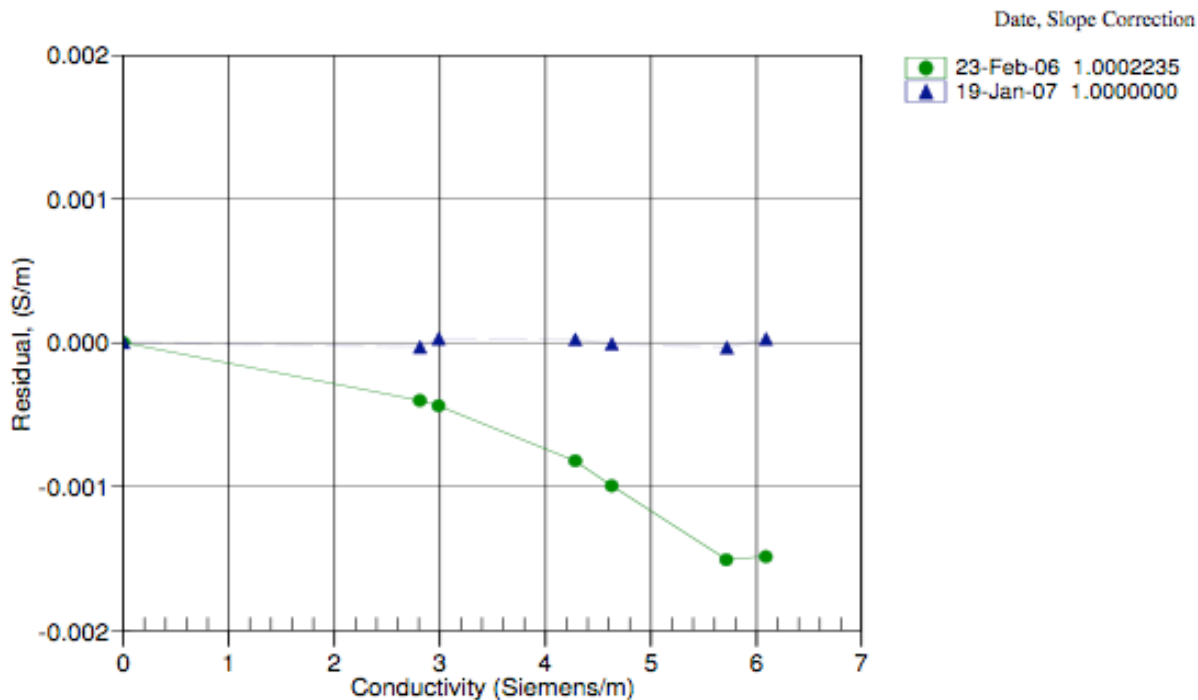

Serial number 2619

SEA-BIRD ELECTRONICS, INC.
 1808 136th Place N.E., Bellevue, Washington, 98005 USA
 Phone: (425) 643 - 9866 Fax (425) 643 - 9954 Email: seabird@seabird.com

SENSOR SERIAL NUMBER: 2619
 CALIBRATION DATE: 19-Jan-07

SBE4 CONDUCTIVITY CALIBRATION DATA
 PSS 1978: C(35,15,0) = 4.2914 Siemens/meter

GHIJ COEFFICIENTS

g = -1.00855638e+001
 h = 1.38321092e+000
 i = -1.07293154e-003
 j = 1.48636626e-004
 CPcor = -9.5700e-008 (nominal)
 CTcor = 3.2500e-006 (nominal)

ABCDM COEFFICIENTS

a = 4.31809229e-006
 b = 1.38064220e+000
 c = -1.00808889e+001
 d = -8.80711205e-005
 m = 5.2
 CPcor = -9.5700e-008 (nominal)

BATH TEMP (ITS-90)	BATH SAL (PSU)	BATH COND (Siemens/m)	INST FREQ (kHz)	INST COND (Siemens/m)	RESIDUAL (Siemens/m)
0.0000	0.0000	0.00000	2.70204	0.00000	0.00000
-1.0001	34.9205	2.81218	5.25857	2.81215	-0.00003
1.0536	34.9202	2.98865	5.37857	2.98868	0.00002
14.9999	34.9203	4.28301	6.18737	4.28303	0.00002
18.4999	34.9199	4.63062	6.38701	4.63061	-0.00001
28.9999	34.9176	5.71703	6.97392	5.71699	-0.00004
32.4999	34.9094	6.09037	7.16443	6.09040	0.00003

Conductivity = $(g + hf^2 + if^3 + jf^4) / 10(1 + \delta t + \epsilon p)$ Siemens/meter

Conductivity = $(af^m + bf^2 + c + dt) / [10(1 + \epsilon p)]$ Siemens/meter

t = temperature[°C]; p = pressure[decibars]; δ = CTcor; ϵ = CPcor;

Residual = (instrument conductivity - bath conductivity) using g, h, i, j coefficients

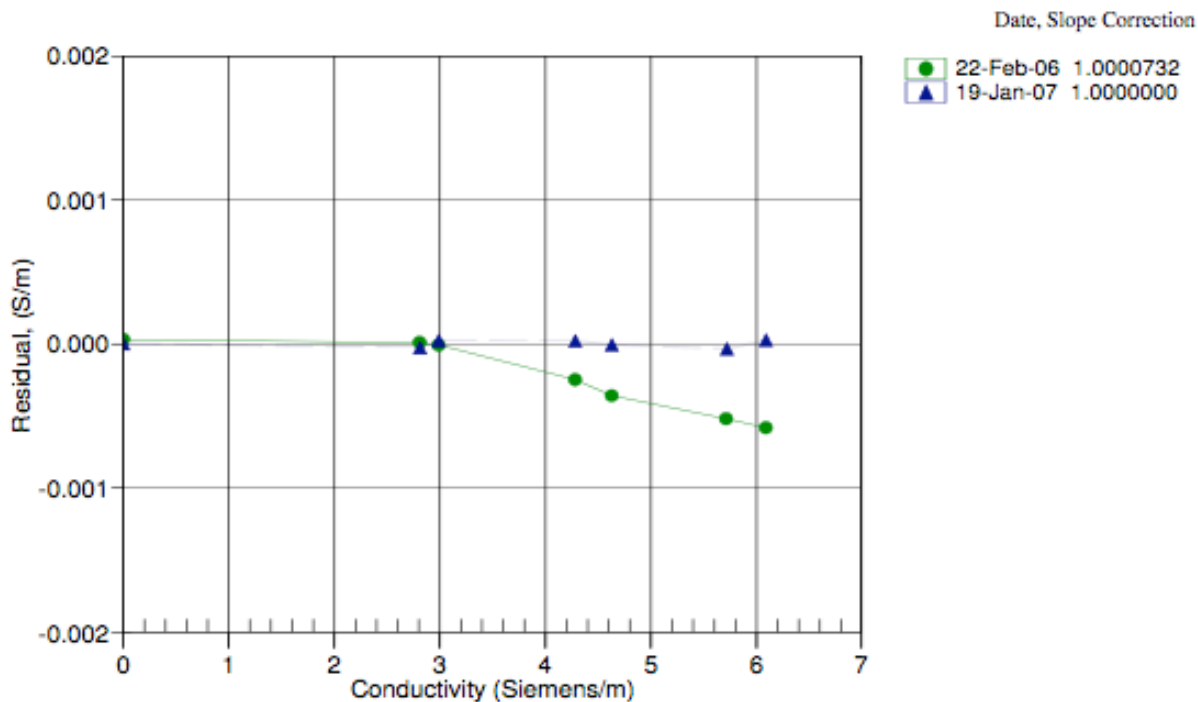

Oxygen

Serial number 0458

SEA-BIRD ELECTRONICS, INC.

1808 136th Place N.E., Bellevue, Washington, 98005 USA

Phone: (425) 643 - 9866 Fax (425) 643 - 9954 Email: seabird@seabird.com

SENSOR SERIAL NUMBER: 0458
CALIBRATION DATE: 10-Feb-07p

SBE 43 OXYGEN CALIBRATION DATA

COEFFICIENTS

Soc = 0.3786

Boc = 0.0000

Voffset = -0.4897

TCor = 0.0006

PCor = 1.350e-04

BATH OX (ml/l)	BATH TEMP ITS-90	BATH SAL PSU	INSTRUMENT OUTPUT(VOLTS)	INSTRUMENT OXYGEN(ml/l)	RESIDUAL (ml/l)
1.22	2.00	0.00	0.822	1.22	0.00
1.22	6.00	0.00	0.860	1.22	0.00
1.23	12.00	0.01	0.917	1.23	0.00
1.24	20.00	0.01	0.999	1.24	-0.00
1.26	26.00	0.01	1.067	1.26	-0.00
1.27	30.00	0.01	1.115	1.27	0.00
4.15	2.00	0.00	1.623	4.15	-0.00
4.16	12.00	0.01	1.936	4.15	-0.00
4.16	6.00	0.00	1.748	4.16	0.00
4.17	20.00	0.01	2.200	4.16	-0.01
4.20	26.00	0.01	2.416	4.19	-0.00
4.21	30.00	0.01	2.563	4.22	0.00
6.45	30.00	0.01	3.667	6.46	0.01
6.52	26.00	0.01	3.482	6.52	-0.00
6.59	20.00	0.01	3.192	6.58	-0.01
6.62	12.00	0.01	2.795	6.62	0.01
6.65	6.00	0.00	2.502	6.65	0.00
6.67	2.00	0.00	2.309	6.67	-0.00

$$\text{oxygen (ml/l)} = (\text{Soc} * (\text{V} + \text{Voffset})) * \exp(\text{TCor} * \text{T}) * \text{Oxsat}(\text{T}, \text{S}) * \exp(\text{PCor} * \text{P})$$

V = voltage output from SBE43, T = temperature [deg C], S = salinity [PSU]

Oxsat(T,S) = oxygen saturation [ml/l], P = pressure [dbar]

Residual = instrument oxygen - bath oxygen

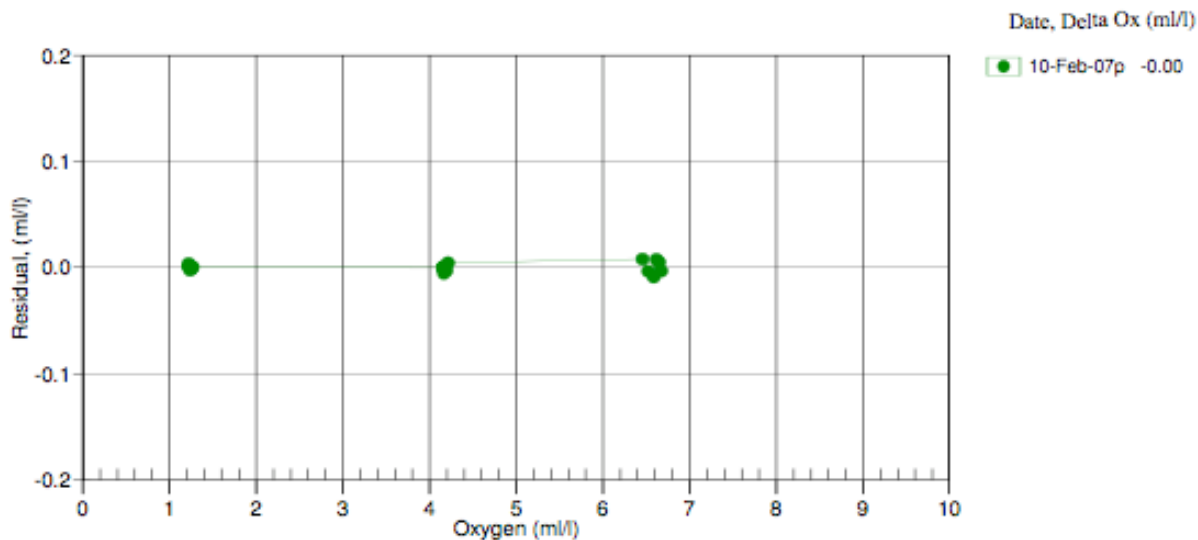

Transmisometer

Serial number CST-390DR

PO Box 518
620 Applegate St.
Philomath, OR 97370



(541) 929-565
Fax (541) 929-527
www.wetlabs.com

C-Star Calibration

Date	February 27, 2007	Customer	US Coast Guard	Work order	004
Job #	0012004	S/N#	CST-390DR	Pathlength	25 cm

	Analog meter
V_d	0.058 V
V_{air}	4.788 V
V_{ref}	4.707 V

Temperature of calibration water	19.8 °C
Ambient temperature during calibration	23.4 °C

Relationship of transmittance (Tr) to beam attenuation coefficient (c), and pathlength (x): $Tr = e^{-cx}$

To determine beam transmittance: $Tr = (V_{sig} - V_{dark}) / (V_{ref} - V_{dark})$

To determine beam attenuation coefficient: $c = -1/x * \ln(Tr)$

V_d Meter output with the beam blocked. This is the offset.

V_{air} Meter output in air with a clear beam path.

V_{ref} Meter output with clean water in the path.

Temperature of calibration water: temperature of clean water used to obtain V_{ref} .

Ambient temperature: meter temperature in air during the calibration.

V_{sig} Measured signal output of meter.

PAR Sensor

Serial number 70115

Calibration Date: 01/09/07	Job No.: 19511
Model Number: QSP2300	
Serial Number: 70115	
Operator: TPC	
Standard Lamp: F-863(9/30/05)	
Operating Voltage Range: 6 to 15 VDC (+)	

Note: The QSP-2300 output is a voltage that is proportional to the log of the incident irradiance. To calculate irradiance, use this formula:

Irradiance = Calibration factor * (10[^]Light Signal Voltage - 10[^]Dark Voltage)

Dry Calibration Factor: 3.22E+12	quanta/cm ² .sec per volt	5.34E-06	μEinsteins/cm ² .sec per volt
Wet Calibration Factor: 5.42E+12	quanta/cm ² .sec per volt	9.00E-06	μEinsteins/cm ² .sec per volt

Sensor Test Data and Results²⁾

Sensor Supply Current (Dark): 3.5 mA		
Supply Voltage: 6 Volts		
Lamp Integrated PAR Irradiance: 9.43E-15	quanta/cm ² .sec	0.01566 μEinsteins/cm ² .sec
SC3 Immersion Coefficient: 0.594		

Nominal Filter OD	Expected Transmission	Calibrated Trans.	Sensor Voltage	Expected Voltage	Voltage Error	Measured Trans.	Transmission Error (%)	Test Irrad. (quanta/cm ² .sec)
No Filter	100%	100.00%	3.467	3.467	0%	100.00%	0.0	9.43E+15
0.3	50%	36.10%	3.007	3.024	-1%	34.66%	4.2	3.27E+15
0.5	32%	27.60%	2.897	2.908	0%	26.87%	2.7	2.54E+15
1	10%	9.27%	2.478	2.434	2%	10.22%	-9.3	9.66E+14
2	1%	1.11%	1.608	1.512	6%	1.35%	-17.7	1.30E+14
3	0.10%	0.05%	0.500	0.194	61%	0.07%	-27.4	1.02E+13

Dark Before:	0.003	Volts
Light - No Filter Hldr.:	3.467	Volts
Dark After - NFH:	0.003	Volts
Average Dark	0.00274	Volts

Notes:
 1. Annual calibration is recommended.
 2) This section is for internal use and for more advanced analysis.

Pressure Sensor

Serial number PO638

SEA-BIRD ELECTRONICS, INC.

1808 136th Place N.E., Bellevue, Washington, 98005 USA

Phone: (425) 643 - 9866 Fax (425) 643 - 9954 Email: seabird@seabird.com

SENSOR SERIAL NUMBER: 0638
CALIBRATION DATE: 05-Dec-06

SBE9plus PRESSURE CALIBRATION DATA
10000 psia S/N 83009

DIGIQUARTZ COEFFICIENTS:

C1 = -4.129335e+004
C2 = -2.366132e-001
C3 = 1.120910e-002
D1 = 3.246900e-002
D2 = 0.000000e+000
T1 = 3.014179e+001
T2 = -1.666793e-004
T3 = 3.283910e-006
T4 = 5.609600e-009
T5 = 0.000000e+000

AD590M, AD590B, SLOPE AND OFFSET:

AD590M = 1.27959e-002
AD590B = -9.20630e+000
Slope = 0.99959
Offset = 0.3996 (dbars)

PRESSURE (PSIA)	INST OUTPUT(Hz)	INST TEMP(C)	INST OUTPUT (PSIA)	CORRECTED INST OUTPUT (PSIA)	RESIDUAL (PSIA)
14.756	33184.50	19.9	14.434	15.013	0.257
2002.227	33972.30	20.2	2002.140	2001.912	-0.315
3989.078	34739.90	20.2	3989.913	3988.877	-0.201
5975.995	35488.70	20.3	5977.918	5976.073	0.078
7963.068	36219.70	20.4	7965.646	7962.993	-0.075
9950.533	36934.30	20.5	9954.010	9950.549	0.016
7962.780	36219.70	20.9	7965.594	7962.942	0.162
5975.625	35488.60	21.0	5977.582	5975.738	0.113
3988.618	34739.80	21.0	3989.576	3988.540	-0.078
2001.699	33972.20	21.1	2001.809	2001.581	-0.118
14.755	33184.50	21.4	14.340	14.920	0.165

Residual = corrected instrument pressure - reference pressure

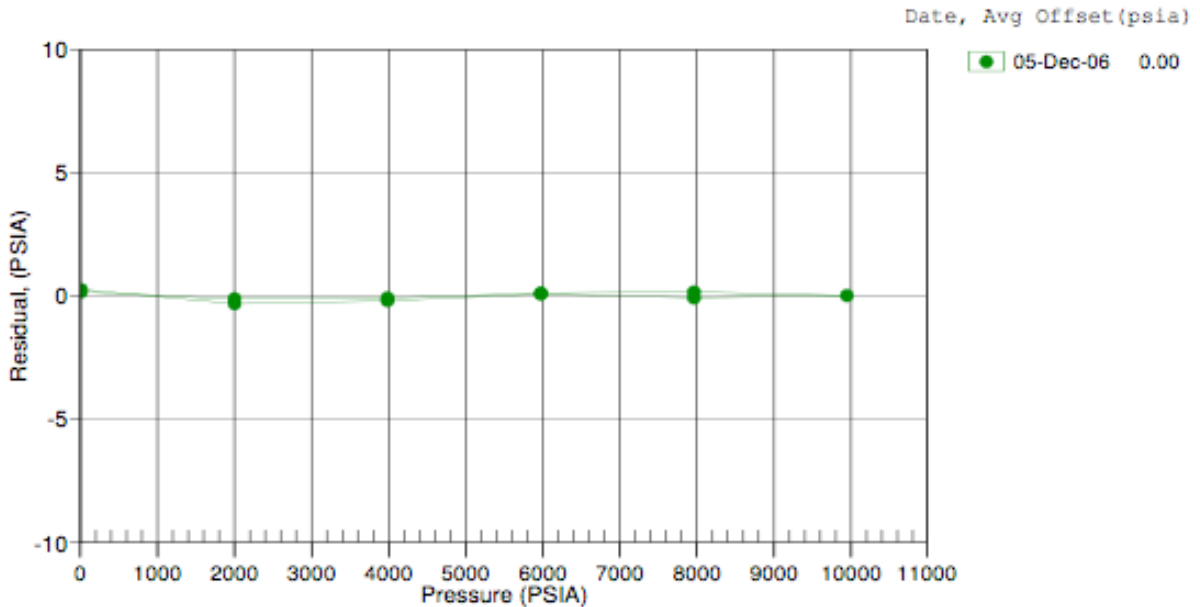

Fluorometer

Serial number 088234

CERTIFICATE OF CALIBRATION

All test equipment and standards used are of known accuracy and are traceable to national standards. Details of test equipment and standards relevant to this certificate are available upon request.



Date of issue	06 March 2007
Description	Mk III Aquatracka (Chlorophyll-a)
Serial Number	088234
Part No	3598C

Chelsea
Technologies
Group

55 Central Avenue
West Molesey
Surrey KT8 2QZ
United Kingdom
Tel: +44 (0)20 8481 9000
Fax: +44 (0)20 8941 9319
sales@chelsea.co.uk
www.chelsea.co.uk

REPORT

The fluorimeter was exposed to various concentrations of Chlorophyll-a dissolved in acetone in addition to pure water and pure acetone. The following formula was derived from the readings to relate instrument output to chlorophyll-a concentration.

$$\text{Conc.} = (0.00779 \times 10^{\text{Output}}) - 0.0211$$

Where -

Conc. = fluorophor concentration in µg/l
Output = Aquatracka output in volts

The above formula can be used in the range 0 - 100 microgrammes per litre to an uncertainty of 0.02 microgrammes per litre plus 5% of value.

Notes

The above formula has been derived using Chlorophyll-a dissolved in acetone. No guarantee is given as to the performance of the instrument to biologically active chlorophyll in sea-water.
The zero offset has been determined in the laboratory using purified water from a reverse osmosis/ion exchange column. It is possible that purer water may be found in clean deep ocean conditions. Under these conditions, the offset shown in the above formula should be replaced by the antilogarithm of the Aquatracka output in the purest water found, multiplied by the scale factor.



Table of Survey measurements

Consolidated Survey Data						
	Elements of:					
		Avondale Survey				
		Westlake Survey				
		Lamont Survey				
All Measurements in <u>Meters</u> relative to MRP unless otherwise stated						
X = fore & aft with + forward						
Y = port & starboard with + to starboard						
Z= vertical with + upwards						
				X	Y	Z
<u>Item</u>	<u>Survey</u>	<u>Description</u>		<u>North</u>	<u>East</u>	<u>Elevation</u>
1	Avondale	MRP	See discussion Westlake Final Report	34.30	0.00	9.15
2	Westlake	MRP	by Definition	0.00	0.00	0.00
3	Westlake	Seabeam 2112				
		Transverse Array	Centerline	-7.679	0.030	9.242
		Longitudinal Array	Centerline	-4.386	0.711	9.238
4	Westlake	Transducers				
		Starboard - Forward to Aft				
		Transducer -	Bathy 2000 3.5 kHz	-10.252	1.362	9.243
		Transducer -	Bathy 1500 34 kHz *	-11.866	1.559	9.245
		Transducer -	Doppler Speed Log	-12.168	0.414	9.245
		Transducer -	Spare Transducer Well	-13.081	1.449	9.237
5	Westlake	Port - Forward to Aft				

HLY0701 Data Synopsis

		Transducer -	VM 150	-9.726	-1.395	9.230
		Transducer -	Ocean Surveyor 75 kHz	-10.819	-1.290	9.230
		Transducer -	Bathy 2000 12 kHz	-11.859	-1.492	9.234
		Transducer -	Spare Transducer Well	-13.078	-1.394	9.235
6	Westlake	Gyros				
		Starboard Gyro	Centerline	4.741	0.207	-19.604
		Port Gyro	Centerline	4.746	-0.207	-19.609
7	Westlake	Antennas				
		REF DWG TBD	Antenna 9-4 * - GPS Antenna (4.1.5)	4.587	-6.622	-24.000
			Antenna 4-6 * - Northstar GPS (4.1.1)	9.374	-4.970	-23.406
			Antenna 4-2 * - Northstar (4.1.2)	9.362	-3.617	-23.451
			P CODE GPS Antenna *	9.368	-2.645	-23.609
			Antenna 4-3 * - Northstar (4.1.4)	9.355	3.638	-23.363
			GLONAS GPS Antenna *	9.379	5.066	-23.515
			Antenna base (4A)	-53.872	-0.011	-22.025
			Antenna base (4B)	-49.758	0.038	-22.010
			Antenna base (4C)	-49.785	1.629	-22.020
			Antenna base (4D)	-49.771	-1.546	-22.008
			Trimble Centurion**	-52.726	-1.717	-21.113
			Time Server **	-52.671	1.838	-21.115
8	Westlake	Vertical Ref				
			MRV-M-MV -			
			Measured at Top of mounting bracket			

HLY0701 Data Synopsis

			Center (mid-point) - calculated	-2.100	0.291	-0.775
			TSS 333B - Marine Motion Sensor -			
			scribe atop mounting plate			
			Center of TSS 333B	1.210	0.329	-0.013
9	LDEO	POS/MV				
		From	TO	X	Y	Z
		IMU	Port Antenna (Master)	-2.9719	-3.9140	-5.5310
		MRP	IMU	-49.5710	1.7110	-16.7990
		MRP	Transmit array	-4.3860	0.7110	9.2380
		MRP	Port Antenna (Master)	-52.5429	-2.2030	-22.3300
10	Westlake Raw	Fan Tail				
			Aft/Port	-86.737	-4.906	-3.617
			Forward/Port	-77.600	-4.881	-3.589
			Forward/Starboard	-72.590	6.676	-3.653

Healy EK50 Installation and Trigger Block Diagram

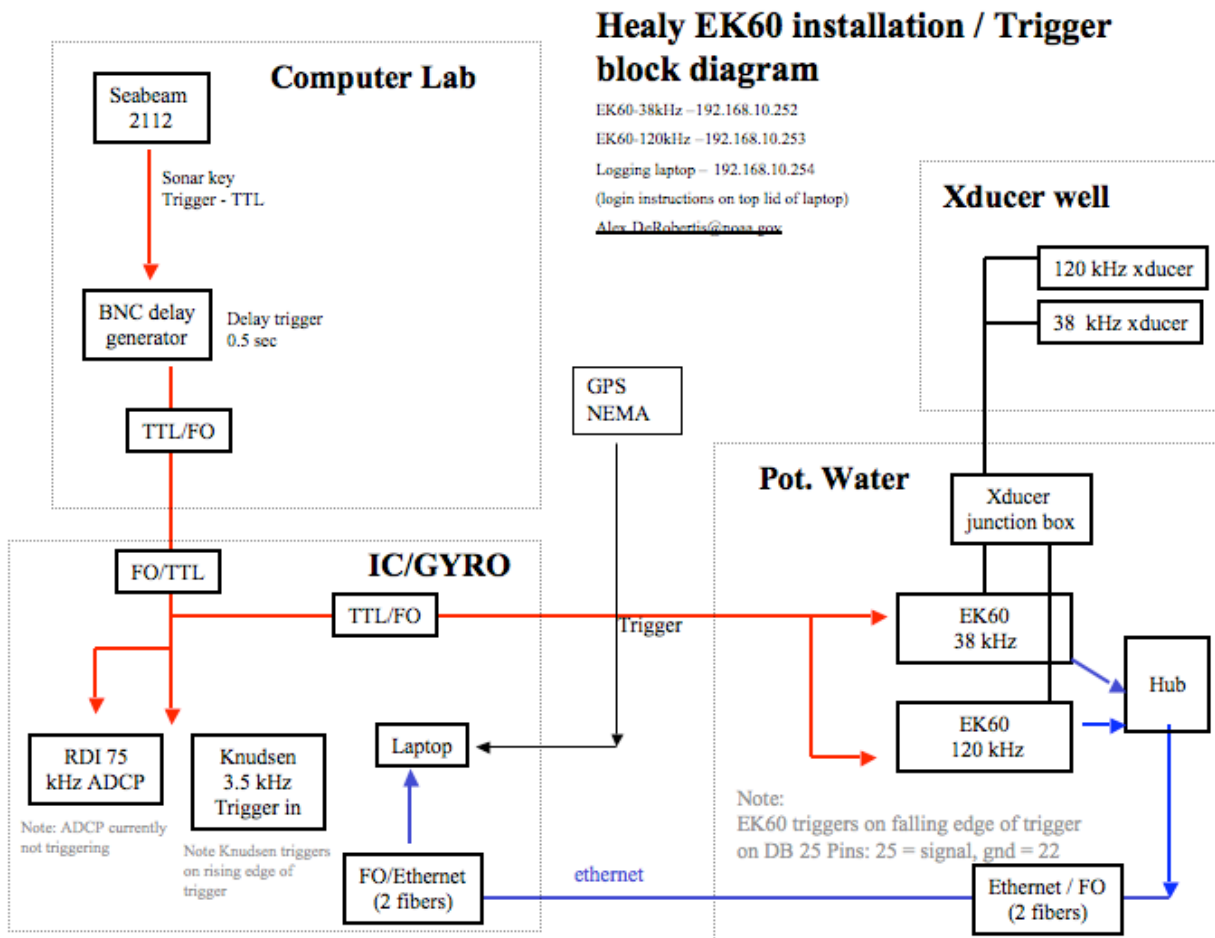

HLY0701 Media Index

The times here are close but not exact. Different files open and close at different times. Use this table to guide you but look at the data itself to be sure how the data is included from one DVD to the next.



HLY0701 Media Files Index

File Name	Dates	Start time	End time	Comments
Media Vol 1	10 April – 12 May 07	20:14	15:00	
Media Vol 2	10-19 April 07	20:14	04:00	
Media Vol 3	19-28 April 07	05:00	17:00	
Media Vol 4	28 April -09 May 07	18:00	06:00	
Media Vol 5	09-12 May 07	07:00	07:00	
Media Vol 6	May 07			

Example list of the DVD directories

First DVD

This is a listing of the first DVD's directories from HLY0701 during the cruise.

media-vol01/Datalog	media-vol01/Datalog/posmv_zda
media-vol01/Datalog/aft_a_frame	media-vol01/Datalog/rmyoung_air
media-vol01/Datalog/air_temp_f	media-vol01/Datalog/rmyportwind
media-vol01/Datalog/ashtech_attitude	media-vol01/Datalog/rmystbdwind
media-vol01/Datalog/ashtech_gga	media-vol01/Datalog/sbd_a_frame
media-vol01/Datalog/ashtech_gll	media-vol01/Datalog/seabeam_center
media-vol01/Datalog/ashtech_hdt	media-vol01/Datalog/sperry_speedlog
media-vol01/Datalog/Compress	media-vol01/Datalog/sv2000
media-vol01/Datalog/dew_point_f	media-vol01/Datalog/true_wind_port
media-	media-vol01/Datalog/true_wind_stbd
vol01/Datalog/EventData/OneMinuteTemplate	media-vol01/Datalog/tsg_aft
media-vol01/Datalog/EventData	media-vol01/Datalog/tsg_flow
media-vol01/Datalog/glonass_gga	media-vol01/Datalog/tsg_fwd
media-vol01/Datalog/glonass_gll	media-vol01/Datalog/winch_data
media-vol01/Datalog/gyro	media-vol01/Meta_Data
media-vol01/Datalog/ibs_waypoints	media-vol01/Meta_Data/elog
media-vol01/Datalog/knudsen	media-vol01/Meta_Data/Bridge_Logs
media-vol01/Datalog/par	media-
media-vol01/Datalog/par_derived	vol01/Meta_Data/Systems_Calibration_Data
media-vol01/Datalog/pcode_aft_gga	media-
media-vol01/Datalog/pcode_aft_gll	vol01/Meta_Data/Systems_Calibration_Data/CTD_Sensors
media-vol01/Datalog/pcode_aft_vtg	media-
media-vol01/Datalog/pcode_aft_zda	vol01/Meta_Data/Systems_Calibration_Data/Underway_Sensors
media-vol01/Datalog/pcode_bridge_gga	media-
media-vol01/Datalog/pcode_bridge_gll	vol01/Meta_Data/Systems_Calibration_Data/Underway_Sensors/MET_Sensors
media-vol01/Datalog/pcode_bridge_vtg	media-
media-vol01/Datalog/posmv_gga	vol01/Meta_Data/Systems_Calibration_Data/Underway_Sensors/Ocean_sensors
media-vol01/Datalog/posmv_gst	
media-vol01/Datalog/posmv_hdt	
media-vol01/Datalog/posmv_pashr	
media-vol01/Datalog/posmv_vtg	

HLY0701 Data Synopsis

media-	media-vol01/Raw/ctd/204
vol01/Meta_Data/HLY0701_Sensors_files	media-vol01/Raw/ctd/205
media-vol01/Meta_Data	media-vol01/Raw/ctd/206
media-vol01/Raw	media-vol01/Raw/ctd/Salts
media-vol01/Raw/ctd	media-vol01/Raw/ctd/current-cfg
media-vol01/Raw/ctd/001	media-vol01/Raw/ctd
media-vol01/Raw/ctd/002	media-vol01/Raw/pos_mv/events
media-vol01/Raw/ctd/003	media-vol01/Raw/pos_mv
media-vol01/Raw/ctd/004	media-vol01/Raw/tsg_fwd
.....	media-vol01/1_Minute_Trk_Data

Second DVD

This is a listing of the second and subsequent DVD's directories from HLY0701 during the cruise.

- ./Images
- ./Images/AloftConnCam
- ./Images/AloftConnCam/2007099
- ./Images/AloftConnCam/2007100
- ./Images/AloftConnCam/2007101
- ./Images/AloftConnCam/2007102
- ./Images/AloftConnCam/2007103
- ./Images/AloftConnCam/2007104
- ./Images/AloftConnCam/2007105
- ./Images/AloftConnCam/2007106
- ./Images/AloftConnCam/2007107
- ./Images/AloftConnCam/2007108
- ./Images/AloftConnCam/2007109
- ./Images/FantailCam
- ./Images/FantailCam/2007099
- ./Images/FantailCam/2007100
- ./Images/FantailCam/2007101
- ./Images/FantailCam/2007102
- ./Images/FantailCam/2007103
- ./Images/FantailCam/2007104
- ./Images/FantailCam/2007105
- ./Images/FantailCam/2007106

./Images/FantailCam/2007107
./Images/FantailCam/2007108
./Images/FantailCam/2007109
./Images/Satellite_Images
./Images/Satellite_Images/dmsp
./Images/Satellite_Images/dmsp/20070409
./Images/Satellite_Images/dmsp/20070410
./Images/Satellite_Images/dmsp/20070411
./Images/Satellite_Images/dmsp/20070412
./Images/Satellite_Images/dmsp/20070413
./Images/Satellite_Images/dmsp/20070414
./Images/Satellite_Images/dmsp/20070415
./Images/Satellite_Images/dmsp/20070416
./Images/Satellite_Images/dmsp/20070417
./Images/Satellite_Images/dmsp/20070418
./Images/Satellite_Images/dmsp/20070419
./Images/Satellite_Images/hrpt
./Images/Satellite_Images/hrpt/20070409
./Images/Satellite_Images/hrpt/20070410
./Images/Satellite_Images/hrpt/20070411
./Images/Satellite_Images/hrpt/20070412
./Images/Satellite_Images/hrpt/20070413
./Images/Satellite_Images/hrpt/20070414
./Images/Satellite_Images/hrpt/20070415
./Images/Satellite_Images/hrpt/20070416
./Images/Satellite_Images/hrpt/20070417
./Images/Satellite_Images/hrpt/20070418
./Images/Satellite_Images/hrpt/20070419
./Raw
./Raw/knudsenraw
./Raw/seabeam
./Raw/adcp75

SBE 21 SEACAT Thermosalinograph Data Output Formats

This is extracted from page 33 of the SBE 21 SEACAT Thermosalinograph User's Manual (SeaBird Manual Version #022, 03/30/07).

The SBE 21 outputs data in raw, hexadecimal form as described below.

The inclusion of some output parameters is dependent on the system configuration - if the specified sensor is not enabled (see *Command Descriptions* above), the corresponding data is not included in the output data stream, shortening the data string.

- SBE 21 Format (**F1**) - ttttccccrrrrrruuuvvvwwxxx (use this format if you will be using SEASAVE to acquire real-time data and/or SBE Data Processing to process the data)
- SBE 16 Format (**F2**) - #ttttccccrrrrrruuuvvvwwxxxnnnn (custom format)

where

tttt = primary temperature

cccc = conductivity

rrrrr = remote temperature (from SBE 38 or SBE 3 remote sensor)

uuu, vvv, www, xxx = voltage outputs 0, 1, 2, and 3 respectively

= attention character

nnnn = lineal sample count (0, 1, 2, etc.)

Data is output in the order listed, with no spaces or commas between parameters. Shown with each parameter is the number of digits.

Calculation of the parameter from the data is described below (use the decimal equivalent of the hex data in the equations).

1. Temperature

$$\text{temperature frequency (Hz)} = (\text{tttt} / 19) + 2100$$

2. Conductivity

$$\text{conductivity frequency (Hz)} = \text{square root} [(\text{cccc} * 2100) + 6250000]$$

3. SBE 3 secondary temperature (if **SBE3=Y**)

$$\text{SBE 3 temperature frequency (Hz)} = \text{rrrrr} / 256$$

4. SBE 38 secondary temperature (if **SBE38=Y**)

$$\text{SBE 38 temperature } psuedo \text{ frequency (Hz)} = \text{rrrrr} / 256$$

5. External voltage 0 (if 1 or more external voltages defined with **SVx**)

$$\text{external voltage 0 (volts)} = \text{uuu} / 819$$

6. External voltage 1 (if 2 or more external voltages defined with **SVx**)

$$\text{external voltage 1 (volts)} = \text{vvv} / 819$$

7. External voltage 2 (if 3 or more external voltages defined with **SVx**)

$$\text{external voltage 2 (volts)} = \text{www} / 819$$

8. External voltage 3 (if 4 external voltages defined with **SVx**)

$$\text{external voltage 3 (volts)} = \text{xxx} / 819$$

Example: SBE 21 with SBE 38 and two external voltages sampled,
example scan = ttttccccrrrrrruuuvvv = A80603DA1B58001F5A21

- Temperature = tttt = A806 (43014 decimal);
temperature frequency = $(43014 / 19) + 2100 = 4363.89$ Hz
- Conductivity = cccc = 03DA (986 decimal);
conductivity frequency =
square root $[986 * 2100] + 6250000 = 2884.545$ Hz
- SBE 38 = rrrrrr = 1B5800 (1,792,000 decimal)
temperature *pseudo* frequency (Hz) = $(1,792,000 / 256) = 7000$ Hz
- First external voltage = uuu = 1F5 (501 decimal);
voltage = $501 / 819 = 0.612$ volts
- Second external voltage = vvv = A21 (2593 decimal);
voltage = $2593 / 819 = 3.166$ volts

Note:

SBE 21 always outputs an even number of voltage characters. If you enable 1 or 3 voltages, it adds a 0 to the data stream before the last voltage, as shown below:

- Remote temperature and 1 voltage enabled –

ttttccccrrrrr0uuu or
#ttttccccrrrrr0uuunnnn

- Remote temperature and 3 voltages enabled –

ttttccccrrrrruuuvvv0www
#ttttccccrrrrruuuvvv0wwwnnnn

Notes:

- Sea-Bird's software (SEASAVE and SBE Data Processing) uses the equations shown to perform these calculations; it then uses the calibration coefficients in the configuration (.con) file to convert the raw frequencies and voltages to engineering units. Alternatively, you can use the equations to develop your own processing software.
- See *Notes on SBE 38 Remote Temperature Data Output Format* below for details on how Sea-Bird handles SBE 38 data.